



**Experts in portable electrical  
equipment for the toughest  
workplaces**





# About Lind Equipment

Lind Equipment is a leading manufacturer of portable electrical products for construction, industrial and hazardous work environments.

For over 70 years Lind has provided the very best in portable lighting, portable power, electrical safety, and static bonding and grounding products for use on the most challenging jobsites.

At Lind we have built our reputation on providing dependable, tough equipment for any industry. From oil and gas to aviation, construction, chemical, and automotive.

After 70 years in the business working with customers in the very toughest work environments, we have established ourselves as a leader in the field.

# Table of Contents

## Contents

Lind Services.....	4
The LED Jobsite.....	5-7
Portable LED Lighting.....	8-30
UVC LED Lighting.....	31-32
Hazardous Location Lighting.....	33-43
Cable Reels.....	44-51
Portable Power & Accessories.....	52-54
Static Bonding & Grounding.....	55-71
GFCIs.....	72-79

**Design Matters. We Have the Awards to Prove it.**



To learn more, please visit: [www.lindequipment.net/awards](http://www.lindequipment.net/awards)

# Lind Services

## Consulting

Lind has spent over 50 years manufacturing and customizing static grounding systems and portable explosion proof lighting. Our products are at work in hazardous environments across a vast array of industries in countries around the world.

We can put this experience to work for you through a "Site Survey" assessment. Our consultants are available to tour your facility and help you determine the best approach to controlling static electricity and deploying portable lighting systems. Often, the fees for this service are reimbursable against the purchase of Lind products.

We can also provide static bonding and grounding training to your workers. On-site tailored to your unique workplace our staff will bring you up to speed on the best practices in safe bonding and grounding.

Don't leave safety to chance. Call on our experience to help safeguard your workplace.

## Customized Solutions

We know that our customers don't work in predictable environments. That is why at Lind, we use our experience to help you address whatever challenges your job might throw at you.

Our design and engineering team excels at providing customized products for unique applications. Whether you need a small adaptation to one of our products to suit your specific needs or in-depth support to determine the appropriate static grounding, portable lighting, cord reel, or portable power system for your application, we can help you come up with a specialized solution that meets your requirements.

We work to ensure that our products do their job so that you can concentrate on doing yours.

Please contact us to discuss your specialized electrical needs.



# The LED Jobsite

A Modular Plug & Play System  
That Will Save Time And  
Money On Your Project

## Reduce Labor and Materials

- Fewer lights required to light the site.
- No bulbs, no maintenance.
- Reduced number of temporary lighting circuits.

## Sustainable Construction

- Up to 90% less energy usage.
- Reduces waste from landfills by reusing products again and again.
- Potential for LEED credit.

## Save with the LED Jobsite

- Save hundreds of thousands of dollars in electricity.
- Improve safety and security.
- Reuse from project to project.

# The LED Jobsite

## The System



### LED Jobsite Light

Beacon360 Blaze

**Watts:** 100W (0.83A at 120V)

**Lumens:** 14,300

**Replaces:** 400W metal halide



### LED Highbay Light

Beacon120 Highbay

**Watts:** 120W (1A at 120V)

**Lumens:** 15,250

**Replaces:** 400W metal halide



### LED Modular Stringlight

Beacon360 Spark

**Watts:** 20W (0.17A at 120V)

**Lumens:** 2,400

**Replaces:** all stringlights



### LED Cart/Crane/Area Floodlight

Beacon980

**Watts:** 200W (1.64A at 120V)

**Lumens:** 30,000

**Replaces:** 1000W metal halide crane light



### LED Task/Portable Light

Beacon970

**Watts:** 40W (0.33A @ 120V)

**Lumens:** 5,945

**Replaces:** 500W quartz-halogen floods



### LED Mobile Tower Light

Beacon LED Tower

**Watts:** 800W (6.67A at 120V)

**Lumens:** 120,000

**Replaces:** a 4 x 1000W metal halide light tower

## Innovative Features

We work to ensure that our products do their job so that you can concentrate on doing yours. LED Jobsite lights are built with high-quality components, ultra-efficient LEDs and innovative features that make your projects run smoother & safer.

- Modular 14/3 SJTW daisy-chain
- Field Serviceable
- 5-year service life
- 90-277V input range
- Built-in surge protection
- Theft-resistant 3-pin Quick Connect
- Wet location rated to meet OSHA requirements
- Drop tested to surpass military grade standards
- Temperature rating -40°F to +104°F (-40°C to +40°C)

# Innovative Features and Benefits

LED Jobsite lights are interchangeable using the daisy-chain system. Swap between large and small fixtures as the jobsite evolves. For example, as a project progresses and walls go up, contractors can simply uninstall the Blaze and swap in a Spark to light individual rooms.

## Beneficial Features

**Plug & play installation.** No pre-wiring, hard-wiring or additional cords required.

**20' & 50' standard cord lengths** to match recommended spacing to meet OSHA standards.

**Quick connect.** Fixtures are installed on the daisy-chain cord set with a theft-resistant, watertight, 3-pin locking connector.

**Triple-tap connector** for branching out to multiple paths off a single circuit.

**14/3 SJTW cord type** to ensure durability and allow for longer circuit runs.

**Field serviceable.** If a cord becomes damaged it can quickly be replaced without requiring a new light fixture



We Plan.



We Deliver.



You Save.

## Free Services

**Temporary Lighting Layouts.** Our team of specialists are here to help. We will provide lighting layouts based on your project floor plans. LED Jobsite layouts factor in data such as OSHA standards, ceiling heights, square footage, ambient lighting, location, etc

**Jobsite Shipping.** Lights are delivered in reusable shipping container with retail packaging removed

**LED Jobsite Success Program.** We will calculate and track the energy and environmental savings your project generates – in real time. Promote your good choices to stakeholders with supplied jobsite signage and a unique live-tracking webpage

**Cost Savings Calculators and Analysis.**

**Assist with LEED Credit.** The LED Jobsite System can qualify for a LEED credit on your project. We will assist with all documentation and calculations

**Site Visits.**

**Guidelines to Specify LED in RFQs for subtrades.**

For more information please visit: [www.LEDJobsite.com](http://www.LEDJobsite.com)



# Portable LED Lighting

At Lind, we know portable lighting. And we know how to illuminate tough environments. We have taken our decades of experience in hazardous location portable lighting and applied that to our heavy-duty and industrial LED lights.

LED Tower Lights.....	9-11
LED Cart Light.....	12-13
LED Floodlights.....	14-19
LED Area Lights.....	20-22
LED Highbay.....	23
LED Dock Lights.....	24
LED Stringlights.....	24-25
LED Hand Lights.....	26-27
Military Lighting & Power.....	28-30
UVC LED Lighting.....	31-32



# LED Tower Lights

## All-In-One Beacon LED Tower

### LE980LEDV-T4-AIO & LE980LEDV-T2-AIO

The Lind Equipment five-time award winning Beacon LED Tower brings you all the light you've come to expect from traditional 4x1000W metal halide light towers, but in a new, revolutionary package. The compact, lightweight, and truly man-portable, All-In-One Beacon LED Tower can be used as a generator powered light tower and as a no-glare diffuser light tower, and an electric powered light tower.

The All-In-One full-power light tower has three modes for different applications. The diffuser mode for roadside construction and events. The electric tower mode for quiet, indoor, fume-free lighting, and a user supplied 1000-2000W generator mode to illuminate remote areas. The All-In-One is a single asset that replaces owning, maintaining and transporting three separate lighting assets. Why own three when you only need one?

The no-glare diffuser frames tightly clip onto the back of the powerful, 30,000 lumen light heads to prevent any movement while in use. Easily adjust the light heads to provide diffused light in the direction you need it most.



### Specs found on Page 11

#### Features:

- Ability to daisy-chain multiple towers and tools
- Use with 'suitcase' type generators, or run off external power
- Direct Drive high-efficiency LED lighting
- Diffuser frames fit into a provided storage case
- Clip on diffuser frames in under one minute
- Fits through man doors and two towers can easily fit in the back of a pick-up truck

#### Approvals:

cETLus Certified

Visit [www.BeaconLEDTower.com](http://www.BeaconLEDTower.com) for more information on the All-In-One

LE980LED-T4-AIO (yellow lay-flat, four light heads)  
LE980LEDV-T4-AIO (yellow vertical, four light heads)  
LE980LED-T4-B-AIO (black lay-flat, four light heads)  
LE980LEDV-T4-B-AIO (black vertical, four light heads)  
*Two light head models also available*

# Portable LED Lighting

## LED Tower Lights

### Vertical or Lay-Flat Beacon LED Tower

LE980LED-T4 & LE980LED-T2

A Beacon LED Tower can be lifted into the back of a pick-up truck, and two towers can fit in the truck bed for easy transportation. The steel frame chassis and mast are robust enough to withstand any job site condition. The Beacon LED Tower can be purchased in lay-flat models or in vertical mast models to fit any application.



**LE980LED-T4** (yellow lay-flat 4 light heads)  
**LE980LED-T4-B** (black lay-flat 4 light heads)

*Two light head models also available*

#### Features:

- Whisper-quiet operation
- Incredibly easy deployment
- Very low maintenance required
- 2 Towers can run on a 15A circuit
- LEDs are maintenance free
- No ballast or bulbs to break
- Use with 'suitcase' type generators, or run off external power

**LE980LEDV-T4-B** (black vertical 4 light heads)  
**LE980LEDV-T4** (yellow vertical 4 light heads)

*Two light head models also available*

#### Industries/Applications:

- Remote work areas
- Construction
- General Contractors
- Night-time road work
- Event lighting
- Concrete pours
- Sports lighting



Visit [www.BeaconLEDTower.com](http://www.BeaconLEDTower.com) for more information on the Beacon LED Tower

# LED Tower Lights

<b>Lights</b>	<b>Power</b>	<b>LE980LEDV-T2-AIO, LE980LEDV-T2, LE980LED-T2: 400W</b> <b>LE980LEDV-T4-AIO, LE980LEDV-T4, LE980LED-T4: 800W</b>
	<b>Amperage</b>	<b>LE980LEDV-T2-AIO, LE980LEDV-T2, LE980LED-T2: 3.3 Amps @120V</b> <b>LE980LEDV-T4-AIO, LE980LEDV-T4, LE980LED-T4: 6.7 Amps @120V</b>
	<b>Lumens</b>	<b>LE980LEDV-T2-AIO, LE980LEDV-T2, LE980LED-T2: 60,000 lumens</b> <b>LE980LEDV-T4-AIO, LE980LEDV-T4, LE980LED-T4: 120,000 lumens</b>
	<b>Voltage</b>	90V-277V
	<b>Ingress protection</b>	IP65 Weatherproof
	<b>Construction</b>	Aluminum housing, polycarbonate lenses
	<b>Rated hours &amp; Temp</b>	Rated for over 50,000 hours - Light Temperature 4,500K
	<b>Approvals</b>	cETLus
<b>Diffusers</b>	<b>Construction</b>	Steel frame with ripstop nylon diffuser covers
<b>Mast</b>	<b>Max Height</b>	<b>LE980LEDV-T4: 17'</b> <b>LE980LED-T4: 20'</b>
	<b>Construction</b>	Steel
	<b>Wind Resistance</b>	45 mph
<b>Chassis</b>	<b>Construction</b>	Steel Frame
	<b>Outriggers</b>	Outriggers extend to 2' beyond frame
	<b>Tires</b>	Foam-filled rubber tires
	<b>Features</b>	Caster wheels • Side access forklift guides • Four rigging points
	<b>Dimensions (stowed)</b>	<b>LE980LEDV-T4: L: 52" • W: 39" (32" fully in) • H: 82"</b> <b>LE980LED-T4:: L: 65" • W: 31" • H: 35" (mast down)</b>
	<b>Weight</b>	<b>LE980LED-T2 (Lay-Flat): 300 lbs</b> <b>LE980LED-T4 (Lay-Flat): 350 lbs</b> <b>LE980LEDV-T2 (Vertical): 350lbs</b> <b>LE980LEDV-T4 (Vertical): 380 lbs</b>
<b>Cabinet</b>	<b>Construction</b>	Steel
	<b>Internal Dimensions</b>	L: 27" • W: 21" • H: 19.5"
	<b>Features</b>	Lockable • Ventilated • On/off switch • Daisy-chain outlet
<b>Fuel Tank</b>	<b>Dimensions</b>	L: 19.3" • W: 12.2" • H: 10.2"
	<b>Capacity</b>	6 Gallons • 23 Litres
	<b>Features</b>	• Comes complete with hose and fuel cap that will fit most popular suitcase generator models. Alternative cap sizes available - call Lind • Removable auxiliary tank
	<i>Run time</i>	Approx 45 hours on standard 2000W suitcase generator with auxiliary fuel tank
<b>Generator</b>		Units do not come standard with a suitcase generator. Lind can also supply for additional cost.

# Portable LED Lighting

## LED Cart Light

### Beacon980 LED Light Cart

LE980LED-CART-TD-W



#### Industries/Applications:

- Construction
- Concrete/Paving
- Excavation
- Military

#### Approvals:

cETLus Certified



#### LE980LED-TRW

6-12' tripod unit with adjustable winch and light head



#### LE980LED-CART-W

19"-12.5' cart unit with light head and winch



#### LE980LED-CART-TD-W

19"-12.5' cart unit with double light head, individual switches and winch

The Beacon980 Cart Light uses the incredibly bright LED light heads from the award-winning Beacon LED Tower to match the light output of 1000W metal-halide light fixtures.

The steel cart itself boasts a winch assisted 12' mast and foam-filled rubber tires for a completely safe and hassle-free operation.

#### Features:

- Lightweight and easily portable
- LEDs will last over 50,000 hours
- No bulb replacement required
- Rated for outdoor use
- Instant start-up, at full output, even in cold temperatures
- Built in pad for portable generator
- Winch assisted 12' mast
- Foam-filled rubber tires

Wattage	200W LED chip (per light head) (1.6A @ 120V)
Lumens	30,000 lumens (per light head)
Voltage	90-277V
Light Temp	4,500K (white light)
Environmental Rating	IP65
Dimensions	17"H x 12.5"W x 6" D
Weight	135 lbs
Construction	All-steel cart, winch assisted mast, foam-filled rubber tires, built-in generator pad.
Cord	15' coiled 16/3 SEOOW cord with 5-15P plug

# LED Cart Light

## Beacon978 LED Light Cart

LE978LED-CART-TD-W



### Benefits:

- Safer working environment
- Lower total cost of ownership
- Reduced downtime on job sites
- Energy saving device for a greener footprint

The Beacon978 Cart Light uses 150W LED light heads that were adapted from the award-winning Beacon LED Tower.

The similarities to traditional metal halide cart lights end there. The Beacon978 LED cart lights will never require bulb changes and don't use an expensive/breakable ballast. They are fully weatherproof and designed to take a huge amount of rough-handling on the jobsite.

### Approvals:

cETLus Certified

<i>Wattage</i>	150W LED chip (per light head) (1.25A @ 120V)
<i>Lumens</i>	22,500 lumens (per light head)
<i>Voltage</i>	90-277V
<i>Light Temp</i>	4,500K (white light)
<i>Environmental Rating</i>	IP65
<i>Dimensions</i>	17"H x 12.5"W x 6"D
<i>Weight</i>	135 lbs
<i>Construction</i>	All-steel cart, winch assisted mast, foam-filled rubber tires, built-in generator pad.
<i>Cord</i>	15' coiled 16/3 SEOOW cord with 5-15P plug



### LE978LED-TRW

6-12' tripod unit with adjustable winch and light head



### LE978LED-CART-W

19"-12.5' cart unit with light head and winch



### LE978LED-CART-TD-W

19"-12.5' cart unit with double light head, individual switches and winch

# Portable LED Lighting

## LED Large Area Floodlights

### Beacon980 LED Floodlight

LE980LED



**Approvals:**  
cETLus and CE Certified

Replace any 1000W metal halide light with the Beacon980 for a safer and smarter lighting solution in any application.

This floodlight utilizes powerful state-of-the-art DirectDrive LED technology, enclosed in a durable weatherproof cast aluminum housing, to ensure dependable performance even in the harshest environments.

The Beacon980 is available on a heavy-duty tripod, all-steel wheeled cart or as just the light head itself for mounting on cranes and poles.

<i>Wattage</i>	200W LED chip (1.67A @ 120V)
<i>Lumens</i>	30,000 lumens
<i>Voltage</i>	90-277V
<i>Light Temp</i>	4,500K (white light)
<i>Environmental Rating</i>	IP65
<i>Dimensions</i>	17"H x 12.5"W x 6" D
<i>Weight</i>	16 lbs per light head
<i>Construction</i>	Cast aluminum housing with polycarbonate lens.
<i>Cord</i>	15' 18/3 SJTW cord with 5-15P plug

# LED Large Area Floodlights

## Beacon978 LED Floodlight

LE978LED



### Features:

- LEDs will last for 5 years of 24/7 use
- No bulb replacement required
- Wet location rated
- Instant start-up, at full output, even in cold temperatures
- Retrofit metal halide light towers

The Beacon978 utilizes the latest advancements in LED technology to provide a bright, uniform light in a rugged, yet compact portable design. No bulbs. No heat. Instant start-up. Bright light everywhere, every time.

<i>Wattage</i>	150W LED chip (1.25A @ 120V)
<i>Lumens</i>	22,500 lumens
<i>Voltage</i>	90-277V
<i>Light Temp</i>	4,500K (white light)
<i>Environmental Rating</i>	IP65
<i>Dimensions</i>	13"H x 12.5"W x 6" D
<i>Weight</i>	14 lbs per light head
<i>Construction</i>	Cast aluminum housing, polycarbonate IP65 light heads
<i>Cord</i>	15' 18/3 SJTW cord with 5-15P plug

### Approvals:

cETLus Certified

# Portable LED Lighting

## LED Floodlights

### Beacon Infinity Light

LE971LED



The Beacon Infinity light revolutionizes the very idea of a floodlight. It's bold and versatile with infinite attachment options. Gone are the days of multiple lights for every job. The high-efficiency LED Infinity light is the one light to replace all others.

#### Features:

- Exceeds military grade drop test requirements
- Lightweight and easily portable
- Replaces all other work lights
- Rated for outdoor use
- Can be placed virtually anywhere with multiple mounting options
- Sleek and innovative design

#### Industries/Applications:

- Fire & Rescue Services
- Military
- General Contractors
- Construction
- Maintenance
- Electrical Contractors

#### Approvals:

cETLus and CE Certified

<i>Wattage</i>	40W LED chip (0.33A @ 120V)
<i>Lumens</i>	5400 lumens
<i>Voltage</i>	90-277V
<i>Light Temp</i>	5,000K (white light)
<i>Environmental Rating</i>	IP65
<i>Dimensions</i>	4.5"W x 14"H
<i>Weight</i>	2.25 lbs
<i>Construction</i>	Aluminum and High Impact Plastic
<i>Cord</i>	15' cord with 5-15P



#### LE971LED-TDM

Heavy-duty tripod, two magnet mounts and two light heads



#### LE971LED-FSM

Heavy-duty tripod, single magnet mount and one light head



#### LE971LED-TRM

Heavy-duty tripod, single magnet mount and one light head



# LED Floodlights

## Beacon Light

LE970LED



**LE970LED-TR**  
4-8' tripod unit with light head

The Beacon Light is the only portable LED floodlight on the market that is built strong enough to withstand the toughest environments without compromising on high-quality light output. This innovative floodlight projects a wide, shadow-free flood of crisp bright white light generated via a 40W LED integrated chip, which is solid-state and can therefore endure shocks, vibrations and rough handling without breaking the LEDs. The Beacon will provide an instant start in even the coldest locations, and the unit remains cool-to-the-touch even if left running for days.

### Features:

- Extremely versatile light for multiple applications
- As bright as a 500W quartz halogen
- Instant start-up at full output even in cold temperatures
- Low energy usage

### Industries/Applications:

- Fire & Rescue Services
- Military
- General Contractors
- Construction
- Maintenance
- Electrical Contractors

### Approvals:

cULus Certified

<i>Wattage</i>	40W LED chip (0.33A @ 120V)
<i>Lumens</i>	5,945 lumens
<i>Voltage</i>	90-277V
<i>Light Temp</i>	4,500K (white light)
<i>Environmental Rating</i>	IP65
<i>Dimensions</i>	7.25"H x 9"W x 5.25"D
<i>Weight</i>	8 lbs
<i>Construction</i>	Cast aluminum housing with polycarbonate lens
<i>Cord</i>	15' of 16/3 SJOW cord with 5-15P plug



**LE970LED**  
Light head and yoke



**LE970LED-FS**  
Floor stand unit with light head



**LE970LED-TD**  
4-8' tripod unit with double light head & individual switches



**LE970LED-MAG**  
Light head with one strong magnet, includes safety chain



**LE970LED-CLAMP**  
Scaffolding clamp unit with light head

# Portable LED Lighting

## LED Floodlights

### Beacon Light Battery Operated

LE965LEDC



**LE965LEDC-TR**  
4-8' tripod unit with light head

The battery powered Beacon Light changes the game completely. Using the newest LED technology, the 40W battery powered Beacon Light puts out the same amount of usable light on your work site as a 500W quartz halogen, without needing to be plugged in.

Ideal for emergency services and first responders, the battery powered Beacon Light is a truly bright floodlight that will illuminate an entire scene.

#### Features:

- Cordless and rechargeable
- Lightweight and easily portable
- Provides up to 25 hours of run time
- Rated for outdoor use
- Rugged heavy-duty construction

#### Industries/Applications:

- Fire & Rescue Services
- Military
- General Contractors
- Construction
- Maintenance
- Emergency Lighting

#### Approvals:

cETLus Certified

<i>Wattage</i>	45W LED chip (0.37A @ 120V)
<i>Lumens</i>	3,000 lumens at 100%
<i>Run Time</i>	4 hours at 100%, 8 hours at 50%, 25 hours at 15%
<i>Charge Time</i>	5 hours
<i>Light Temp</i>	4,500K (white light)
<i>Environmental Rating</i>	IP65
<i>Dimensions</i>	7.25"H x 9"W x 5.25"D
<i>Weight</i>	8 lbs

*Construction* Cast aluminum housing, carrying handle, adjustable yoke with wing nuts, 120V charger, polycarbonate lens



**LE965LEDC**  
Light head and yoke



**LE965LEDC-FS**  
Floor stand unit with light head



**LE965LEDC-TD**  
4-8' tripod unit with double light head & individual switches



**LE965LEDC-MAG**  
Light head with one strong magnet, includes safety chain



**LE965LEDC-CLAMP**  
Scaffolding clamp unit with light head

# LED Floodlights

## Hornet Light Battery Operated

LE961LED



### Industries/Applications:

- DIY Handyman
- Service Technicians
- Small Contractors

Lind Equipment has continued to innovate and created a brand new, portable and powerful version of the Hornet Light. Small but powerful, this battery operated Hornet Light comes complete with 180 degree rotatable bracket, USB power bank output and magnets for easy placement. Contractors can rest assured that the Hornet Light is durable, bright and easy to use for any job.

### Features:

- Surpassed military drop test requirements
- Compact to fit in any toolbox
- Quick charging time and long battery life
- Extremely versatile light for multiple applications
- Charge anywhere in anyway that is most convenient for you: AC, DC or USB
- Rotate or angle 180° bracket in any direction to always have the proper amount of light exactly where you need it

<i>Wattage</i>	15W
<i>Lumens</i>	1,700 lumens
<i>Run Time</i>	3 hours full power and 6 hours on low power
<i>Charge Time</i>	3.5 hours (includes charging and discharging protection)
<i>Light Temp</i>	4,500K (white light)
<i>Environmental Rating</i>	IP65
<i>Dimensions</i>	5.9"H x 5.9"W
<i>Weight</i>	2 lbs
<i>Construction</i>	Aluminum and rubber bumpers
<i>Accessories</i>	AC adapter (5V, 2A), USB cable, 12V DC car adapter
<i>Voltage</i>	3.6V chargers included

# Portable LED Lighting

## LED Area Lights

### Beacon360 Blaze

LE360LED



**LE360LED-TR**  
4-8' tripod unit with light head

Meet the Beacon360 Blaze. The most versatile and durable temporary light on the market. This compact and portable unit provides 14,300 lumens of bright, white light for up to 50' in all directions at full power. What makes the Blaze unique is its versatility. Use it as task lighting on a tripod to illuminate an entire room, on a metal beam or clamped to a skyscraper. Even daisy-chain it as part of the LED Jobsite System for large area lighting. Whatever your project lighting needs are, the Beacon360 Blaze will meet it.

#### Features:

- Surpasses military grade drop test requirements
- Lightweight and easily portable
- Rated for outdoor use
- Rugged heavy-duty construction

<i>Wattage</i>	100W LED chip (0.83A @ 120V)
<i>Lumens</i>	14,300 lumens at 100% 7,150 at 50%
<i>Voltage</i>	90-277V
<i>LED Life</i>	50,000 hours of 24/7 use
<i>Light Temp</i>	4,500K (white light)
<i>Environmental Rating</i>	IP65 - Wet location rated
<i>Dimensions</i>	10.5"H x 6"D
<i>Weight</i>	4.5 lbs
<i>Construction</i>	Cast aluminum housing, polycarbonate lenses and rubber bumpers
<i>Cord</i>	Standard 15' of 13/3 SJOW cord with 5-15P

#### Industries/Applications:

- Fire & Rescue Services
- Military
- General Contractors
- Construction
- Maintenance
- Aviation

#### Approvals:

cETLus and CE Certified



**LE360LED**  
Light head and yoke



**LE360LED-FS**  
Floor stand unit with light head,



**LE360LED-25P25C**  
25' cord and 5/15P and daisy-chain 25' cord and triple 5-15C connector



**LE360LED-MAG**  
Light head with one strong magnet, includes safety chain



**LE970LED-CLAMP**  
Scaffolding clamp unit with light head

# LED Area Lights

## Beacon360 GO Battery Operated

LE360LEDC



**LE360LEDC-TR**  
4-8' tripod unit with light head

The LE360LEDC is a high-efficiency battery operated LED floodlight that provides unparalleled portability and illumination for wet locations, remote sites or otherwise inaccessible areas. High efficiency LEDs coupled with cutting-edge battery technology provide users with the versatility and control to customize light output based on their exact needs.

### Features:

- Eliminate extension cords and generators
- Lightweight and easily portable
- Battery technology provides 4-25 hours of run time
- Rated for outdoor use
- Rugged heavy-duty construction

<i>Wattage</i>	45W LED chip (0.37A @ 120V)
<i>Lumens</i>	6,000 lumens at 100%
<i>Voltage</i>	90-277V
<i>Run Time</i>	4 hours at 100%, 8 hours at 50%, 25 hours at 15%
<i>Charge Time</i>	4-5 hours
<i>Light Temp</i>	4,500K (white light)
<i>Environmental Rating</i>	IP65
<i>Dimensions</i>	12"H x 6.5"D
<i>Weight</i>	9 lbs
<i>Construction</i>	Cast aluminum housing with polycarbonate lenses and rubber bumpers

### Industries/Applications:

- Fire & Rescue Services
- Military
- General Contractors
- Construction
- Maintenance
- Aviation

### Approvals:

cETLus and CE Certified



**LE360LEDC**  
Light head and yoke



**LE360LEDC-FS**  
Floor stand unit with light head



**LE360LEDC-MAG**  
Light head with one strong magnet, includes safety chain



**LE970LED-CLAMP**  
Scaffolding clamp unit with light head

# Portable LED Lighting

## LED Area Lights

### Beacon360 Spark

LE360LEDS-10P10C



#### Industries/Applications:

- Replaces all types of stringlights
- Corridors/stairwells
- General Contractors
- Construction
- Maintenance

#### Approvals:

cETLus and CE Certified

The Beacon360 Spark replaces traditional stringlights for increased efficiency and flexibility. Eliminate the hassles of stringlights not being bright enough, getting caught between walls, requiring frequent upkeep – just to be sent to the landfill at the end of the job.

#### Features:

- Effortlessly branch off into individual rooms or in other directions as required
- 40% less energy usage compared to LED bulb-based stringlights
- Theft-resistant

Wattage	20W LED chip (0.17A @ 120V)
Lumens	2,400
Voltage	90-277V
LED Life	50,000 hours of 24/7 use
Light Temp	4,500K (white light)
Environmental Rating	IP64 - Wet location rated
Dimensions	7"H x 2.7"D
Weight	1.5 lbs
Construction	High impact plastic & aluminum housing with polycarbonate lens
Cord	Daisy-chain cord with 10 foot and a 5-15P on one end and a 10 foot cord with a triple tap on the other

# LED Highbay

## Beacon120 Highbay

LE-HB120LED



### Industries/Applications:

- Area lighting for high ceiling heights
- General Contractors
- Warehousing
- Industrial expansion and construction

### Approvals:

cETLus and CE Certified

The Beacon120 drastically reduces the labor, material and maintenance requirements associated with temporary highbay lighting. Installation is quick and easy with no rewiring required to accommodate different voltages.

### Features:

- Uses state-of-the-art DirectDrive technology
- Exceeds military grade drop-test requirements
- Easy to install, uninstall and transport
- Weatherproof - certified for outdoor use
- Plug & play right out of the box

Wattage	120W LED chip (1A @ 120V)
Lumens	15,250
Voltage	90-277V
LED Life	50,000 hours of 24/7 use
Light Temp	4,500K (white light)
Environmental Rating	IP65 - Wet location rated
Dimensions	2"H x 12"D
Weight	2.6 lbs
Construction	High strength lightweight aluminum housing with polycarbonate lens



### LE-HB120LED-25P25C

25' cord and 5-15P and daisy-chain  
25' cord and triple 5-15C connector



### LE-HB120LED

3' 18/3 STJOW cord with  
5-15P plug

# Portable LED Lighting

## LED Dock Lights & Stringlights

### L41LED

#### Heavy-Duty LED Dock Light



**Approvals:**  
cULus Certified

**Features:**

- 40" tubular extension arm with five pivot points and mounting hardware

The L41LED uses only a fraction of the energy of a quartz halogen or incandescent light while providing a bright, uniform light to fully illuminate even the longest of trailers. The light gives off almost no heat, meaning a much safer light with little or no maintenance. Heavy duty enough to withstand the rugged environment of a typical loading dock area, the L41LED has what it takes to ensure you can get your job done safely and efficiently.

<b>L41LED</b>	Light with glass lens
<b>L41LED-PL</b>	Light with polycarbonate lens
<b>LED</b>	High output LED array - 38W total (rated 50,000 hours)
<b>Lumens</b>	3,500 lumens
<b>Weight</b>	11 lbs
<b>Light Temp</b>	5,700K (white light)
<b>Construction</b>	Aluminum fixture, tubular steel arm, tempered glass lens

### LE7055-W

#### Linear LED Stringlights



**Industries/Applications:**

- Portable shelters
- Tunnel construction and maintenance
- Aircraft maintenance
- Transit vehicle maintenance
- Temporary construction lighting

**Approvals:**  
CSA and CE Certified

Lind Equipment's linear LED stringlights are highly versatile portable lighting fixtures that provide bright white light and are built with military grade materials. These stringlights have been shock and vibration tested to military standards and have been deployed and tested for military and civilian applications.

<b>LED</b>	55W LED lamp array (rated over 50,000 hours)
<b>Lumens</b>	5,500
<b>Voltage</b>	120-240V
<b>Light Temp</b>	4,500K (white light)
<b>Construction</b>	Aluminum housing with polycarbonate lens and rubberized end caps
<b>Environmental Rating</b>	IP65
<b>Dimensions</b>	36"L x 6"W
<b>Weight</b>	8 lbs



# LED Stringlights

## TLS-50SJ14LED TLS-100SJ14LED Stringlights



**Approvals:**  
cETLus Certified

**Replacement Guard:**

- P/N **TLS-PG** (plastic)



**Replacement Guard:**

- P/N **TLS-MGC** (enclosed metal)
- P/N **TLS-MG** (open metal)



For tough, temporary lighting shipped complete with 100W equivalent LED bulbs, the LED stringlights can't be beat. The rugged cable is high visibility yellow and can withstand the toughest treatment. The TLS has hanging holes on each socket allowing installation with either spikes or S-hooks. Each model comes standard with enclosed metal or plastic guards to deter theft and a connector, (TLS-100CG14LED does NOT have a connector).

**Features:**

- 80% more energy efficient than traditional incandescent stringlights
- Incredibly durable design will ensure long term use without damage or downtime
- Can be linked together for longer runs
- Highly visible yellow cable

<i>LED</i>	14W High-output LED lamp with standard Edison (E-26) base. 100W incandescent equivalent
<i>Lumens</i>	1,500 Lumens per bulb (more usable light than 100' traditional incandescent stringlights)
<i>Replacement Bulb</i>	TLS-LEDCG-P2
<i>Beam Angle</i>	220° per bulb

Part Number	Length	# Of Sockets	Guard	Weight	Cable	Connector
<b>TLS-100CG14LED</b>	100'	10	Plastic	15 lbs	14/2 SJTW	NO
<b>TLS-50SJ14LED</b>	50'	5	Plastic	9 lbs	14/3 SJTOW	YES
<b>TLS-100SJ14LED</b>	100'	10	Plastic	16 lbs	14/3 SJTOW	YES
<b>TLS-50MGSJ14LED</b>	50'	5	Enclosed Metal	11 lbs	14/3 SJTOW	YES
<b>TLS-100MGSJ14LED</b>	100'	10	Enclosed Metal	20 lbs	14/3 SJTOW	YES

# Portable LED Lighting

## LED Hand Lights

### Beacon360 Torch Battery-Operated Hand Lamp

LE360LEDHC



**Approvals:**  
cETLus Certified

The new Beacon360 Torch, Battery Operated handlamp is the most versatile portable hand light available. This light comes with four lighting modes to best suit your task. 360 degrees high power mode, 360 degrees low power mode, 180 degrees mode and flashlight mode.

**Features:**

- Instant start up in cold weather
- Wet location rated
- Durable, compact and easily portable
- Charge with a car DC charger or an AC wall charger

<i>Wattage</i>	15W LED chip (0.12A @ 120V)
<i>Lumens</i>	360° High - 1,100 lumens 360° Low - 500 lumens 180° Mode - 300 lumens Flashlight Mode - 320 lumens
<i>Dimensions</i>	11.5"H x 3.32"D
<i>Light Temp</i>	5,000K (white light)
<i>Construction</i>	Rubber handle & bumpers & aluminum heat sink
<i>Run Time</i>	360° High - 4 hours 360° Low - 8 hours 180° Mode - 10 hours Flashlight Mode - 10 hours
<i>Charge Time</i>	5 hours
<i>Environmental Rating</i>	IP65

# LED Hand Lights

## LE1725LED

### Heavy-Duty LED Work Light



**Approvals:**  
cETLus Certified

This light is also available on a cord reel, see page 50.

Our incredibly popular line of heavy-duty work lights now has a new LED model. The LE1725LED work light has quickly become the favourite choice for customers across the country. Using the latest in LED technology, these virtually indestructible work lights have no bulbs to replace, are a lightweight rugged design, and come equipped with dual steel rotatable hanging hooks.

LED	2 x 4W high output white LEDs. Extra LED on top end for flashlight mode
Lumens	480 lumens
Dimensions	11.5"L x 2.25"W
Weight	1 lb
Light Temp	5,700K (white light)
Construction	Polycarbonate lens, Nylon 66 rubber handle and end cap. 25' 18/2 SJTOW cord
LE1725LED	25' of 18/2 SJTOW cord and plug

## LED5015G

### Industrial LED Work Light



**Approvals:**  
cETLus Certified

This light is also available on a cord reel, see page 50.

Packing 50 LEDs into a compact space, the LED5015G is bright white light where you need it most. It incorporates a 13A convenience outlet in the handle so that you can plug in additional tools. The LED5015G also comes with a removable magnet mount and dual hooks so that it can be positioned exactly where you need it.

LED	50 LED, 3.39W
Lumens	112 lumens
Construction	Molded plastic housing. 15' 16/3 SJT cord.
Dimensions	15"L x 3.5"W x 2"H
Weight	2.9 lbs

# Portable LED Lighting

## Military Lighting & Power

### Temporary Power Distribution

91060 Military 60A Portable Power Distribution Unit  
(NSN 6110-20-008-4674)



**Approvals:**  
CSA Certified

The Portable Power Distribution Unit is designed to safely distribute temporary power in areas such as shelter camps. 125V/20A receptacles on the unit are protected by individual GFCIs with "Power On" indicators that also provide open neutral and reverse phasing protection. Over-current protection is provided by a full complement of circuit breakers located under an easy-access side panel.

---

*Receptacles* 1 x 125V/250V/60A input (560B9W)

---

*Receptacles* 1 x 125V/250V/60A pass-thru for daisy-chaining units (560R9W)

---

*Receptacles* 1 x 125V/20A NEMA 5-20R GFCI protected receptacles

---

*Dimensions* 14.5"W x 26.5"L x 11.5"H

Custom units available. We can do higher power versions and different receptacle configurations. Call us with your requirements.

# Military Lighting & Power

## Expedition Light LE7055

LED Military Stringlights



### Approvals:

CSA and CE Certified

### Expedition Light Individual Fixtures

#### Base Model:

## LE7055-W

#### Options to add on:

- **G** **Covert Mode:**  
G = NVIA green A, R= red, B=blue
- **EM** **Emergency Mode:**  
When power is cut, lights stay on at reduced level for over 3 minutes without the use of batteries
- **F** EMI filter removes any EMI interference to MIL-STD 461, RE102, CE102, RS103 (ground) standards
- **CB** Central control functionality allows the power and covert mode to be controlled by modular control boxes. System requires control boxes if this is selected (see page 30). All the fixtures connected in same series need same option.

Incredibly durable and highly advanced, the Expedition Tactical LED Lighting System brings everything you need to light your shelters in challenging environments. Expedition lights are dynamic and provide a wide range of optional features and system configurations to meet all requirements.

Expedition lights are twice as bright as most other solutions, meaning less lights required, reduced cost, set up/take down time, and logistical concerns.

Optional unlimited modular control boxes offer flexible control of all lights from any point in the shelter. Or control brightness, power and covert mode at the individual fixtures.

<i>LED</i>	55W high output LED lamp array. LED rated life over 50,000 hours.
<i>Lumens</i>	5,000 lumens
<i>Environmental Rating</i>	IP67
<i>Weight</i>	~ 10 lbs (varies based on order)
<i>Specifications</i>	EMI compliant to MIL-STD 461 (RE102, CE102, RS103 for ground equipment). Patented
<i>Construction</i>	Virtually unbreakable polycarbonate lens and backbone, aluminum heat sink and rubber end caps. String up to 16 lights together. System connects to 120V or 240V power. Operates from -40°C/-40°F to 49°C/120°F. Optional -51°C/-51°F version available.

# Portable LED Lighting

## Military Lighting & Power

### LE7055 Optional Accessories

<b>LE7055-CC</b>	Central control box; 1 required per shelter if central control option (-CB) chosen on fixtures
<b>LE7055-AC</b>	Auxillary control box; add as many of these as required for multiple control points in shelter if central control option (-CB) is chosen on fixtures
<b>LE7055-P46B</b>	Waterproof case with custom foam that holds up to 2 lights and 1 control box
<b>LE7055-P46</b>	Waterproof case with custom foam that holds up to 3 lights
<b>LE7055-P47</b>	Soft padded carrying case that holds 2 lights and 1 control box

Field serviceable. Replacement parts also available.

Detailed specs and ordering information at [www.LindEquipment.net/military](http://www.LindEquipment.net/military)

### TLS-FALK

Field Accommodation Lighting Kit  
(NSN 6230-20-006-0369)



**Approvals:**  
cULus Certified

Military shelter lighting kit designed for traditional lighting applications. Kit comes with metal guard protected string lights. CFL bulbs, S-hooks and a circuit-breaker protected 25' extension cord. All contents are contained within a custom-foam protected waterproof transit case.

<i>Stringlight</i>	32' STW 12/3 stringlight with 4 metal-guard protected lamp sockets spaced 8' apart. 4' input and output lengths. 5-15P plug and 5-15R receptacle.
<i>Bulb</i>	4 high-efficiency 26W CFL spiral bulbs
<i>Hooks</i>	50 metal S-hooks
<i>Extension Cord</i>	25' 12/3 SJTW cord with circuit-breaker protected triple 5-15R outlet
<i>Transit Case</i>	38" x 16" x 6" waterproof rugged case with custom protective foam inserts (included)

# Victory UVC LED Decontamination System

## Victory UVC LED System

PROVEN TO KILL >99.99% OF SARS-COV-2

### Precautions:

- Never have humans or animals present in the room when UVC light is energized
- UVC LED lights do NOT give off visible light
- Red warning LEDs inform users when light is operating

### LE6725UVC-1P1C

Victory Agile UVC LED Light



### LE6725UVC-ST

Victory Agile UVC LED Light Stand

The Victory UVC LED Decontamination System combines cutting-edge LED technology and smart design to create a flexible UVC engine that can be customized for use in any decontamination device for shared spaces and equipment.

Our Victory UVC LED Decontamination System drives our own decontamination products and those of cutting-edge manufacturer partners. Reach out to us if you have some interest in our products or partnering to use the Victory UVC LED Decontamination System to power your own ideas.

Lind Equipment's original UVC LED Portable light. Utilized by governments, medical offices and businesses to decontaminate shared spaces, this light has won two awards and was the testing unit when we proved this technology killed SARS-CoV-2.



<i>Wattage</i>	50W LED chip (0.42A @ 120V)
<i>Beam Angle</i>	60°
<i>UVC Output</i>	110 uW/cm <sup>2</sup> at 1 metre using 275nm wavelength
<i>Environmental Rating</i>	Indoor only, do not expose to water
<i>Voltage</i>	90-277V
<i>Dimensions</i>	22"L x 5.25"W x 2.5"D
<i>Weight</i>	5.25 lbs
<i>Construction</i>	Steel construction with UV resistant coating

# UVC LED Lighting

## Victory UVC LED Decontamination System

### LE6728UVC-CHIP

#### Victory Chip UVC LED Cleaner



The Victory Chip Cleaner is a small, portable unit that decontaminates casino chips using the Victory UVC LED decontamination system. Within a few seconds, 20 casino chips can emerge completely decontaminated and free of SARS-CoV-2 and many other viruses.

<i>Wattage</i>	56W
<i>UVC Output</i>	14mJ/cm <sup>2</sup> of UVC dose applied to both sides
<i>Environmental Rating</i>	Indoor only, do not expose to water
<i>Voltage</i>	120V/15A outlet A/C power
<i>Dimensions</i>	13"W x 13"L x 11.25"H
<i>Weight</i>	35 lbs
<i>Construction</i>	Steel construction

### LE6713UVC-FLK/ LE6713UVC-HLK

#### Victory Secure UVC LED Locker Retrofit Kit

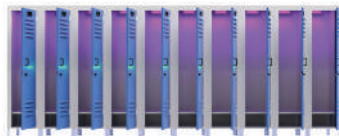

The Victory Secure UVC LED Locker Decontamination Retrofit Kit can be easily installed by anyone into a locker to decontaminate between uses. This kit is perfect for shared locker spaces in gyms or factories.

<i>UVC Output</i>	15mJ/cm <sup>2</sup> of UVC dose applied from the top and the bottom of the locker
<i>Environmental Rating</i>	Indoor only, do not expose to water
<i>Voltage</i>	120V/15A outlet A/C power then converts into DC power inside the locker
<i>LE6713UVC-FLK</i>	Full-locker kit for standard lockers 5'.9" high
<i>LE6713UVC-HLK</i>	Half-locker kit for any locker shorter than 3' high
<i>Decon Time</i>	3 minutes. The system will shut off automatically and reset if door is open

### LE-VICADV

#### Victory Advance UVC LED Decon Conveyor

The Victory Advance UVC Decontamination Conveyor is a portable unit that can decontaminate packages and equipment on all sides as the item moves through the conveyor.

Using Lind's proven Victory UVC LED technology, the conveyor has different conveyor speeds that allows for different doses of UVC during the decontamination process.

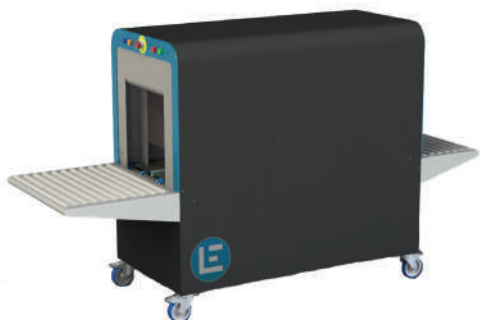

<i>UVC Output</i>	Adjustable conveyor speed allows for dose levels of 25 mJ/cm <sup>2</sup> (most viruses, including proven SARS-CoV-2 >99.99%) and 50 mJ/cm <sup>2</sup> (viruses and a wide swath of bacteria)
<i>Environmental Rating</i>	Indoor only, do not expose to water
<i>Voltage</i>	120V/15A outlet A/C power
<i>Dimensions</i>	58"W x 100"L x 35" D *approximate size, can be custom built for your application*





# Hazardous Location Lighting

Lind Equipment is a global powerhouse in the hazardous location lighting world. We supply almost all of the Class, Division and Groups requirements that you may have.

Haz Loc Classifications.....	34
LED Hand Lamp & Low-Voltage.....	35-37
Hand Lamp Inspection Light.....	38-39
Explosion Proof Floodlights.....	40
Explosion Proof Stringlights.....	41
Low Voltage Explosion Proof Stringlights.....	42
Haz Loc Headlight.....	43
Explosion Proof Extension Cord.....	43

# Hazardous Location Lighting

## Classifications

Hazardous location lighting equipment needs to be approved for the specific type of hazardous location in which you are working. This is because the lights are built with the specific hazard in mind and engineered to keep workers safe from that specific set of hazards.

Typically, a plant electrician will determine the classification of the hazardous location involved. Below is a table outlining the basics of hazardous location classification. More detailed information is located on our website at [www.lindequipment.net](http://www.lindequipment.net) in the Resources section.

If you have any questions or would like to discuss your hazardous location needs, please do not hesitate to give us a call.

**Every location is assigned a Class, Division and Group. Here is a brief summary:**

<b>Class I</b>	Flammable gases/vapours may be present in the air in quantities sufficient to produce explosive/flammable mixtures
<b>Division 1</b>	Explosion hazard may exist during normal operations or repair/maintenance operations
<b>Division 2</b>	Explosion hazard is normally confined within closed containers or systems, or the area is adjacent to a Division 1 area from which the explosive gases might occasionally flow
<b>Class II</b>	Combustible dust or electrically conductive combustible dust may be present
<b>Division 1</b>	Electrically conductive combustible dust may be present, or A hazardous amount of combustible dust may be present during normal operations, or as a result of a malfunction in the presence of an ignition source
<b>Division 2</b>	Combustible dust may accumulate and interfere with the heat dissipation of electrical equipment, or where the accumulation of dust may be ignited
<b>Class III</b>	Easily ignitable fibres and flyings are present, but not likely to be suspended in air in quantities sufficient to produce ignitable mixtures

Equipment approved for Division 1 is also suitable for use in Division 2 areas.

Class I and II areas are further sub-divided by Groups; only equipment that has been approved for a specific Group should be used in an area classified as belonging to that Group. The following is a brief summary of some of the hazards found in each group:

Class I Groups		Class II Groups	
A	Acetylene	E	Metal dusts such as aluminum and magnesium
B	Hydrogen, arsine, butadiene	F	Carbonaceous dusts such as coal and coke
C	Diethyl ether, ethylene, cyclopropane	G	Grain, flour, and starch dusts
D	Gasoline, ethanol, natural gas, propane, acetone, benzene, butane, hexanes, naphtha, toluene		

# LED Hand Lamp & Low-Voltage Option

## XP162LED

LED Hand Lamp



A rugged Tuffite handle and aluminum guard make this a mainstay of the hazardous location line. Light is operable at 120V, 240V or low-voltage 12V.

Standard models include 16/3 SOOW cord and non-explosion proof plug

<b>XP162LED</b>	LED Handlamp only
<b>XP162LED-25P</b>	with 25' cord and plug
<b>XP162LED-50P</b>	with 50' cord and plug
<b>XP162LED-100P</b>	with 100' cord and plug
<b>XP162-P1</b>	LED Bulb Replacement

**Approvals:**

cULus Certified for Class I, Division 1, Groups C and D

All XP lights are available with optional cords and plugs. Need an explosion proof plug? Need a different type or length of cord? No problem! Just ask.

## GST50LED

Low-Voltage  
Explosion Proof  
Hand Lamp  
(US Only)



Our XP162LED with a 12V inline transformer.

<b>GST50</b>	LED bulb with a 120V > 12V inline transformer and 50' cord with plug
<b>XP2112LED</b>	LED Bulb Replacement

<i>Bulb</i>	100W LED (0.83A @120V)
<i>Light Output</i>	800 lumens
<i>Construction</i>	Tuffite phenolic handle, aluminum guard, tempered glass globe
<i>Length</i>	18.5"
<i>Diameter</i>	5"
<i>Weight</i>	4 lbs (less cable)

**Approvals:**

cULus Certified for Class I, Division 1, Groups C and D (light head only)

# Hazardous Location Lighting

## Hand Lamp & Low-Voltage Option

### XP87B

Compact  
Fluorescent  
Hand Lamp



#### Approvals:

cULus Certified for Class I, Division 1, Groups C and D. Class II, Division 1, Groups F and G

Fluorescent bulbs generate minimal heat, making these lamps ideal for use in confined spaces. These lights are approved for Class I and II hazardous areas, making them versatile choices for a range of applications. Available in 120V and low-voltage 12V versions (12V versions for US only).

Standard models include 16/3 SOOW cord and non-explosion proof plug

<b>XP87B</b>	26W 120V hand lamp only
<b>XP87B-25P</b>	with 25' cord and plug
<b>XP87B-50P</b>	with 50' cord and plug
<b>XP87BD-100P</b>	with 100' cord and plug
<b>XP874B</b>	Fluorescent Replacement

### GSFB50

Low-Voltage  
Explosion Proof  
Hand Lamp  
(US Only)



#### Approvals:

cULus Certified for Class I, Division 1, Groups C and D. Class II, Division 1, Groups F and G (light head only)

Our quad-tube XP87B fluorescent hand lamp with a 12V inline transformer.

<b>GSFB50</b>	6W fluorescent lamp with a 120V > 12V inline transformer and 50' cord with plug
<b>XP874B</b>	Fluorescent Replacement

<i>Bulb</i>	26W quad-tube
<i>Light Output</i>	1,800 lumens
<i>Construction</i>	Dupont ZYTEL outer construction is extremely rugged and leaves no exposed metal parts. Tempered glass globe.
<i>Length</i>	23"
<i>Diameter</i>	4"
<i>Weight</i>	3.5 lbs (less cable)

# Hand Lamp Low-Voltage

## XP99

Low-Voltage  
Handheld Explosion  
Proof Spotlight



### Approvals:

cULus Certified for Class I, Division 1,  
Group D

The XP99 is designed for those hazardous locations where you need to get light directly on the job that you are doing, rather than lighting up the entire area. Low-voltage operation makes it ideal for tank and wet location inspections.

<b>XP99</b>	50W 12V spotlight only
<b>2150-95</b>	Halogen Replacement
<i>Bulb</i>	50W 12V halogen spot bulb (50W halogen flood bulb also available)
<i>Construction</i>	Tuffite phenolic handle, aluminum guard, tempered glass globe
<i>Lumens</i>	450 lumens (0.42A @ 120V)
<i>Length</i>	16"
<i>Diameter</i>	5.5"
<i>Weight</i>	3 lbs (less cable)

# Hazardous Location Lighting

## Hand Lamp Inspection Light

### XP65LED

#### LED Inspection Light



The XP65's low operating temperature, narrow diameter, and lightweight design make it well suited for confined space applications. It is extensively used in the aviation industry, especially for fuel cell and wing tank inspections.

*Standard models include 16/3 SOOW cord and non-explosion proof plug*

#### Approvals:

cULus Certified for Class I, Division 1, Group D. Class II, Division 1, Group G

<b>XP65LED</b>	LED array inspection light only
<b>XP65LED-25P</b>	with 25' cord and plug
<b>XP65LED-50P</b>	with 50' cord and plug
<b>XP65LED-75P</b>	with 75' cord and plug
<b>XP65LED-100P</b>	with 100' cord and plug
<b>XP65LED-P1</b>	LED array

Retrofit your existing XP65 to use the new LED array! **P/N XP65LED-P1.**

<i>Bulb</i>	High intensity LED array
<i>Light Output XP65LED</i>	250 lumens
<i>Construction</i>	Tuffite phenolic handle, aluminum guard, tempered glass globe
<i>Length</i>	27"
<i>Diameter</i>	2.5"
<i>Weight</i>	3 lbs (less cable)

# Hand Lamp Inspection Light

## XP25

Portable  
Incandescent  
Inspection Light



### Approvals:

cUL and UL Certified for Class I, Division 1, Groups C and D

The XP25 can be used as an inspection light in a number of industries including aircraft maintenance and drum inspection. With a diameter of under 2", this light will fit in tight spaces that no other hazardous location light can go, making it a particular favorite of the drum inspection industry. Meets several MIL-SPECS and has approved NSN numbers. The XP25H comes standard with a 30" handle extension.

<b>XP25-100P</b>	with 100' cord and plug (NSN 6230-00-266-8646 AND 6230-00-283-9671)
<b>XP25H-100P</b>	with 30" handle and 100' cord and plug (NSN 6230-00-095-3674)
<b>XP25-P1</b>	Replacement Bulb

<i>Bulb</i>	25W incandescent bulb (0.21A @ 120V)
<i>Light Output</i>	230 lumens
<i>Construction</i>	Tuffite phenolic handle, aluminum guard
<i>Length</i>	16.75"
<i>Diameter</i>	1 11/16"
<i>Weight</i>	1.3 lbs (less cable)

# Hazardous Location Lighting

## Explosion Proof Floodlights

### XP970LED

Explosion-Proof LED Floodlight



<b>XP970LED-50P</b>	Light with 50' cord and non-xp plug
<b>XP970LED-TR</b>	4-8' tripod unit with light head
<b>XP970LED-CLAMP</b>	Scaffolding clamp unit with light head
<b>XP970LED-FS</b>	Floor stand unit with light head
<b>XP970LED-MAG</b>	Light with strong magnet

The bright and portable XP970LED is a new and improved explosion proof light with a high-powered LED within. Standard models include a 16/3 SOOW cord and non-xp plug.

Wattage	40W (0.33A @ 120V)
Lumens	5,600 lumens
Voltage	90-277V
Light Temp	4500K
LED Life	50,000 hours
Construction	Cast aluminum housing with tempered glass lens
Dimensions	3.75"D x 11"H x 12.5"W
Weight	17 lbs (less cable)

#### Approvals:

cULus Certified for Class I, Division 1, Groups B, C and D. Class II, Division 1, Groups E, F and G

### XP980LED

Explosion-Proof LED Floodlight

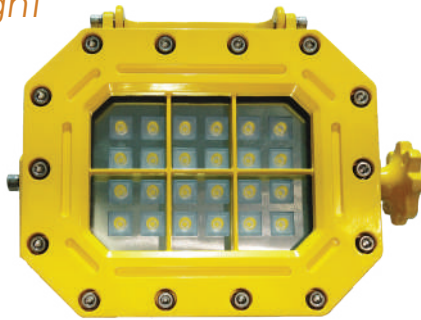

<b>XP980LED-50P</b>	Light with 50' cord and non-xp plug
<b>XP980LED-TR</b>	4-8' tripod unit with light head
<b>XP980LED-MAG</b>	Light with strong magnet

Brighter and more powerful than the XP970LED, this explosion proof floodlight has all the benefits of the smaller model, with more power.

Wattage	200W (1.66A @ 120V)
Lumens	24,000 lumens
Voltage	90-277V
Light Temp	4500K (bright white light • no blue tint)
LED Life	50,000 hours
Construction	Cast aluminum housing with tempered glass lens
Dimensions	3.75"D x 14"H x 15.5"W
Weight	35 lbs (less cable)

#### Approvals:

cULus Certified for Class I, Division 1, Groups B, C and D. Class II, Division 1, Groups E, F and G

All XP lights are available with optional cords and plugs. Need an explosion proof plug? No problem! Just ask.



# Explosion Proof Stringlights

## TLS-XP & TLS-XPLED

### Explosion-Proof Stringlights



#### Approvals:

cQPSus Certified for Class I, Division 1, Groups C and D hazardous locations (conforms to CSA and UL standards)

These stringlights are designed and approved to be used in hazardous locations by incorporating incandescent explosion-proof hand lamps into sturdy t-drops and cable. They come in 100' and 50' lengths, with a light every 10 feet. These come with an Appleton explosion-proof plug (ECP-1523) and connector (ECCL-2023) or bare ends, but can be configured further to match your needs. LED and bulb versions available.

<i>Bulb</i>	A21 rough service bulb or 100W equivalent LED bulb
<i>Light Output LED</i>	800 lumens per work light
<i>Light Output Bulb</i>	800 lumens per work light
<i>Cord</i>	12/3 SOOW

#### LED:

Part No.	Length	# Of Sockets	Plug	Receptacle	Lead	Tail	Weight	Light Output
TLS-100XPLED	100'	10	Class 1, Div 1 XP plug	Class 1, Div 1 XP connector	9'	1'	90 lbs	8,000
TLS-100XPLEDBL	100'	10	Bare end (no plug)	Bare end (no connector)	9'	1'	90 lbs	8,000
TLS-100XPLEDRE	115'	10	Regular (non-haz loc) plug	Blunt end (cannot daisy-chain)	25'	N/A	90 lbs	8,000
TLS-80XPLED	80'	8	Class 1, Div 1 XP plug	Class 1, Div 1 XP connector	9'	1'	70 lbs	6,400
TLS-50XPLED	50'	5	Class 1, Div 1 XP plug	Class 1, Div 1 XP connector	9'	1'	50 lbs	4,000
TLS-50XPLEDBL	50'	5	Bare end (no plug)	Bare end (no connector)	9'	1'	50 lbs	4,000
TLS-50XPLEDRE	65'	5	Regular (non-haz loc) plug	Blunt end (cannot daisy-chain)	25'	N/A	50 lbs	4,000

# Hazardous Location Lighting

## Low-Voltage Explosion Proof Stringlights

### TLS-50XPLEDRE-LV, TLS-80XPLEDRE-LV & TLS-100XLEDPRE-LV

Low-Voltage  
Explosion-Proof  
Stringlights

Illuminate your hazardous location work areas easily and safely with this LED explosion proof stringlight. Made with tough, durable, certified and proven LED hazardous location lights, this stringlight will meet the OSHA requirements for lighting a construction area while keeping your workers safe.

We've even added in a low-voltage driver at the start to allow you to use this in the presence of water or water-blasting operations. Plug this stringlight into any standard power outlet OUTSIDE the hazardous location, and then bring the stringlights into your work zone. Plug and low-voltage transformer are not rated for hazardous locations.



#### Approvals:

cQPSus Certified for Class I, Division 1, Groups C and D (CSA and UL Standards)

<i>Voltage</i>	120V light > 12V inline transformer
<i>Wattage</i>	Pre-installed, factory tested 10W replaceable LED bulb (60W equivalent)
<i>Light Output</i>	850 lumens per bulb
<i>Construction</i>	15-15P non-explosion proof plug, 10' of cord, low-voltage transformer, 50' of cord, followed by your # of LED lights spaced 10' apart

Part Number	# Of Lights	Amps	Weight	Light Output
TLS-50XPLEDRE-LV	5	0.75A	95 lbs	4,000
TLS-80XPLEDRE-LV	8	1A	75 lbs	6,400
TLS-100XPLEDRE-LV	10	1.5A	55 lbs	8,000

# Headlight - Explosion-Proof Extension Cords

## HL-X

### Hazardous Location Headlight



#### Approvals:

cULus Certified for Class I, Division 1, Groups C and D hazardous locations

Bring the light with you with our explosion proof headlight. Fitting comfortably directly on your head or on your hard hat, this light will focus on the immediate area in front of you, leaving your hands free to work.

<i>Bulb</i>	R15 Flashlight bulb
<i>Construction</i>	Durable and chemically resistant polypropylene
<i>Weight with Batteries</i>	220g (7.6oz)
<i>Battery</i>	Requires 4 AA cells. Battery burn time is approximately 6 hours with alkaline cells
<b>HL-501</b>	Replacement Bulb

## LE12

### Explosion-Proof Extension Cords



#### Approvals:

Class I, Division 1, Groups B, C and D. Class II, Division 1, Group G coal dust

These extension cords are designed and approved to be used in hazardous locations. Simply wiring explosion-proof plugs and connectors to a length of wire does not constitute an approved product. Safeguard your people and equipment and comply with safety codes by buying Lind's approved explosion-proof extension cords.

<i>Cord</i>	12/3 SOOW
<b>LE12-50XP</b>	50' 12/3 SOOW cable with explosion-proof plug and connector
<b>LE12-100XP</b>	100' 12/3 SOOW cable with explosion-proof plug and connector



# Cable Reels

Eliminate the problem of power cords lying on the floor where they can become tangled, damaged, or act as a tripping hazard for personnel.

We offer a wide array of heavy duty and industrial strength reels in both automatic and manual wind variations. Many of our reels can be custom configured with various lights and outlets in order to meet your specific need.

Auto Rewind Reels.....	45-50
Hand Wind Reels.....	51

## Auto Rewind Cord Reels

### LE9600 Series

Heavy-Duty High Capacity Indoor/Outdoor Reels

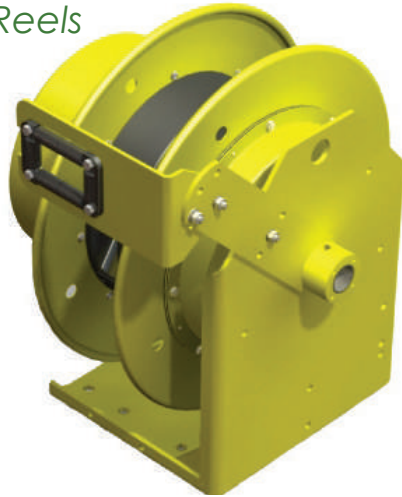

Lind's heavy-duty reels in a very high capacity format. For those applications that use larger gauge cable or require extra long runs of 12 gauge cable.

#### Features:

- Heavy duty all-steel construction
- NEMA 4 weatherproof enclosure
- Slip ring AMP ratings from 35-150A
- Cable guide arm can be mounted along 375° arc
- Cable lengths up to 100', with up to 12 conductors

#### Approvals:

CSA Certified

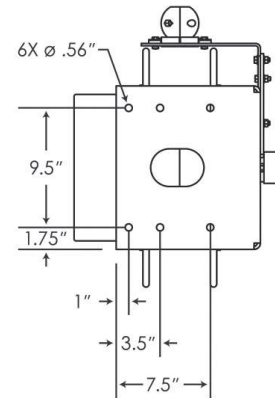
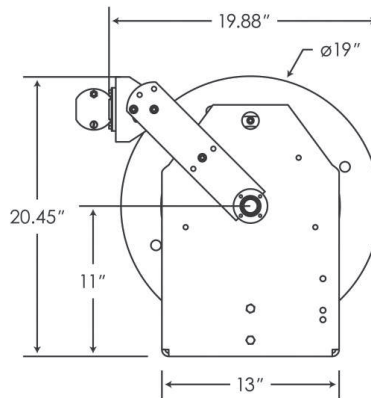
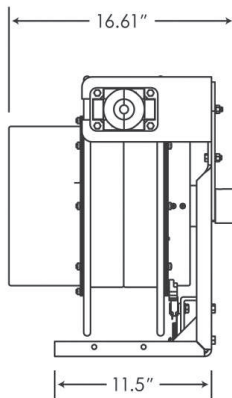

#### 12 Gauge:

<b>LE9680123BE</b>	80' of 12/3 SOW cable
<b>LE96100123BE</b>	100' of 12/3 SOW cable
<b>LE9650125BE</b>	50' of 12/5 SOW cable
<b>LE96100125BE</b>	100' of 12/5 SOW cable

#### 8 Gauge:

<b>LE9630083BE</b>	30' of 8/3 SOW cable
<b>LE9660083BE</b>	60' of 8/3 SOW cable
<b>LE9630084BE</b>	30' of 8/4 SOW cable
<b>LE9650084BE</b>	50' of 8/4 SOW cable

#### 10 Gauge:

<b>LE9680103BE</b>	80' of 10/3 SOW cable
<b>LE96100103BE</b>	100' of 10/3 SOW cable
<b>LE9680104BE</b>	80' of 10/4 SOW cable
<b>LE96100104BE</b>	100' of 10/4 SOW cable
<b>LE9640106BE</b>	40' of 10/6 SOW cable
<b>LE9680106BE</b>	80' of 10/6 SOW cable

### Other configurations available!

Including 6 gauge and 4 gauge options. Call us with your requirements.

# Cable Reels

## Auto Rewind Cord Reels

### LE9500 Series

Heavy-Duty  
Indoor/Outdoor  
Reels



Lind Equipment also offers our heavy-duty reel in a high-capacity version. The same all-steel weatherproof construction from our LE9000 series reels, but in a larger format. Perfect for tough workplaces that require higher gauge cable, longer lengths, or many conductors.

#### Features:

- Adjustable cable guide arm (12 positions)
- Strong ratchet that can be disengaged for constant tension
- NEMA 4X weatherproof rating on enclosure
- Adjustable ball stop
- Comes with 2' extra cable for feeder cord
- Cable lengths up to 80', with up to 12 conductors

#### Approvals:

CSA and UL Certified

#### Dimensions - Inches (mm)

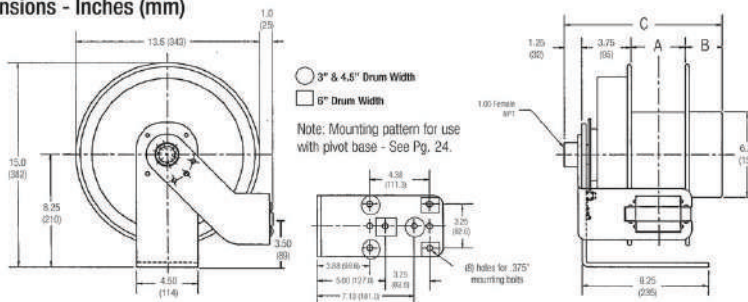

A = 3" to 6" (76-152)    B = 3.5" to 8.5" (89-216)    C = 13" to 18" (330-457)

[ A, B, and C dimensions depend on the exact reel configuration - Contact Factory ]

#### 30 Foot SOOW Cable:

<b>LE9530143QB1</b>	14/3 cable w/ 15A quad box
<b>LE9530123QB2</b>	12/3 cable w/ 20A quad box
<b>LE9530143S1</b>	14/3 cable w/ 15A single outlet
<b>LE9530123S2</b>	12/3 cable w/ 20A single outlet
<b>LE9530103S2</b>	10/3 cable w/ 20A single outlet
<b>LE9530143BE</b>	14/3 cable bare ends (rated up to 15A)
<b>LE9530123BE</b>	12/3 cable bare ends (rated up to 20A)
<b>LE9530103BE</b>	10/3 cable bare ends

#### 50 Foot SOOW Cable:

<b>LE9550143QB1</b>	14/3 cable w/ 15A quad box
<b>LE9550123QB2</b>	12/3 cable w/ 20A quad box
<b>LE9550143S1</b>	14/3 cable w/ 15A single outlet
<b>LE9550123S2</b>	12/3 cable w/ 20A single outlet
<b>LE9550103S2</b>	10/3 cable w/ 20A single outlet
<b>LE9550104BE</b>	50' of 10/4 SOW cable
<b>LE9550143BE</b>	14/3 cable bare ends (rated up to 15A)
<b>LE9550123BE</b>	12/3 cable bare ends (rated up to 20A)
<b>LE9550103BE</b>	10/3 cable bare ends

#### Other configurations available!

LE9500 reels come standard with up to 80' of SOOW cable and bare ends. See optional accessories and most popular SKUs. Further customization is available on demand.

#### 80 Foot SOOW Cable:

<b>LE9580143LED</b>	14/3 cable w/ LED hand lamp
<b>LE9580143QB1</b>	14/3 cable w/ 15A quad box
<b>LE9580143S1</b>	14/3 cable w/ 15A single outlet
<b>LE9580143BE</b>	14/3 cable bare ends (rated up to 15A)

# Auto Rewind Cord Reels

## LE9000 Series

Heavy-Duty  
Indoor/Outdoor  
Reels



Dimensions - Inches (mm)

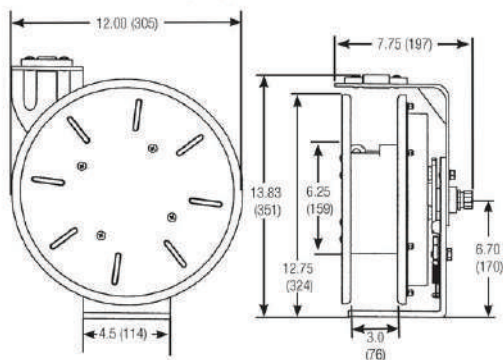

Our LE9000 series of reels are built with durable all-steel weatherproof (NEMA 4 enclosure) construction so that they will survive in the toughest work environments. We've built the cable guide arm with thicker steel than our competitors to take extra abuse. All this while still keeping the form factor small so that your reel isn't always in the way.

### Features:

- Precision construction to allow years of use with little maintenance
- Adjustable cable guide arm (12 positions)
- Strong ratchet that can be disengaged for constant tension
- Adjustable ball stop
- 6' feeder cord
- Standard SJOW cable in various gauges
- Cable lengths up to 50', with up to 4 conductors
- NEMA 4 weatherproof rating on enclosure

### Approvals:

CSA and UL Certified

### 25/30 Foot SOW Cable

<b>LE9030143LED</b>	14/3 cable w/ LED hand lamp
<b>LE9030143QB1</b>	14/3 cable w/ 15A quad box
<b>LE9025123QB2</b>	12/3 cable w/ 20A quad box
<b>LE9030143S1</b>	14/3 cable w/ 15A single outlet
<b>LE9025123S2</b>	12/3 cable w/ 20A single outlet
<b>LE9030143BE</b>	14/3 cable bare ends (rated up to 15A)
<b>LE9025123BE</b>	12/3 cable bare ends (rated up to 20A)

### 50 Foot SOW Cable

<b>LE9050163LED</b>	16/3 cable w/ LED hand lamp
<b>LE9050143QB1</b>	14/3 cable w/ 15A quad box
<b>LE9050123QB2</b>	12/3 cable w/ 20A quad box
<b>LE9050143S1</b>	14/3 cable w/ 15A single outlet
<b>LE9050123S2</b>	12/3 cable w/ 20A single outlet
<b>LE9050143BE</b>	14/3 cable bare ends (rated up to 15A)
<b>LE9050123BE</b>	12/3 cable bare ends (rated up to 20A)

The LE9000 series reels come with a variety of cable types and accessories. See below for optional accessories and most popular SKUs. Further customization is available on demand.

# Cable Reels

## Auto Rewind Cord Reels

### LE8900 Series

Heavy-Duty  
Indoor Reels



Lind's heavy-duty reel in a more compact, value-oriented model. For tough indoor only applications, the LE8900 series will perform while saving you money.

#### Features:

- Heavy-duty reinforced steel frame with molded nylon
- 20A, 125V slip ring
- 6' feeder cord, adjustable ball stop
- Ceiling, wall or bench mount
- Quick-install base plate

#### Approvals:

cULus Certified

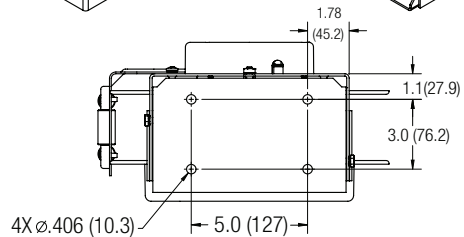
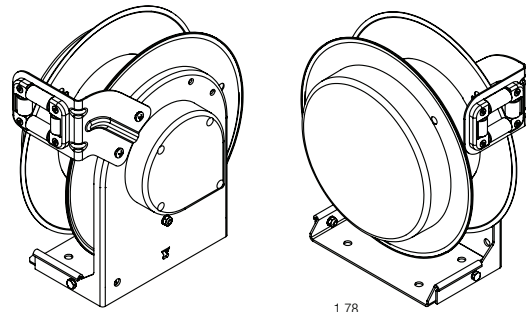
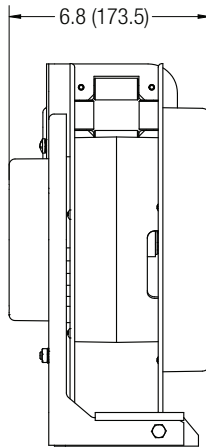
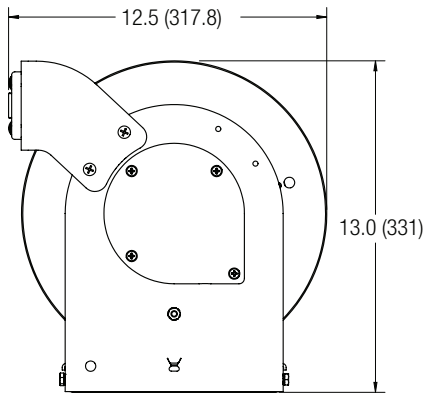

#### 35 Foot 12/3 SJOOW Cable:

<b>LE8935123BE</b>	with bare ends
<b>LE8935123S1</b>	with single 15A outlet
<b>LE8935123S2</b>	with single 20A outlet
<b>LE8935123QB1</b>	with 15A quad box
<b>LE8935123QB2</b>	with 20A quad box
<b>LE8935123LED</b>	with LED hand lamp

#### 50 Foot SOOW Cable:

<b>LE8950123BE</b>	with bare ends
<b>LE8950123S1</b>	with single 15A outlet
<b>LE8950123S2</b>	with single 20A outlet
<b>LE8950123QB1</b>	with 15A quad box
<b>LE8950123QB2</b>	with 20A quad box
<b>LE8950123LED</b>	with LED hand lamp



# Auto Rewind Cord Reels

## LE8000 Series

Industrial  
Indoor Reels



The 8000 Series offers excellent flexibility for your jobsite. It can be mounted on a ceiling or wall for convenient access or, with a quick press of the release tab, be converted into a portable reel with a large carrying handle. The high quality, non-metallic composite housing is durable enough to be used in industrial settings and will never corrode.

**Approvals:**  
cULus Certified

Call us for custom industrial reels, including OEM applications such as carts, mobile payment kiosks, etc.

Part No.	Cable Length	Cord Type	End Feature	Outlet Rating	Size (LxWxH)	Weight	Reel Colour	Cord Colour
<b>8040-T</b>	40'	12/3 SJTW	Triple Outlet	15A circuit breaker protected	11.5"L 5.25"W 15.5"H	13.0 lbs	Black	Yellow
<b>8050-T</b>	50'	14/3 SJTW	Triple Outlet	13A circuit breaker protected	11.5"L 5.25"W 15.5"H	12.5 lbs	Black	Yellow
<b>8050-103</b>	50'	14/3 SJTW	LE103 incandescent work light	13A circuit breaker protected	11.5"L 5.25"W 15.5"H	13.5 lbs	Black	Yellow
<b>8050-DPL</b>	50'	16/3 SJTW	DPL 26W	15A circuit breaker protected	11.5"L 5.25"W 15.5"H	13.0, lbs	Black	Yellow
<b>8045-S2</b>	45'	12/3 SJTW	15A/20A outlet	20A circuit breaker protected	11.5"L 5.25"W 15.5"H	13.5 lbs	Black	Black



**Triple Outlet**



**DPL**



**LE103**



**15A/20A Outlet**

# Cable Reels

## Auto Rewind Cord Reels

### LE2000 Series

Industrial  
Indoor Reels



The 2000 Series is an excellent option for industrial environments where a small but highly durable cable reel is required. With a strong steel housing and epoxy finish, this reel is tough enough for most industrial environments. At only 9 1/4" in diameter, it also stores a large amount of cable in a relatively small package. The reel comes with hardware for both ceiling and wall mounting to allow for convenient placement.

**Approvals:**  
cULus Certified

Part No.	Cable Length	Cord Type	End Feature	Outlet Rating	Size (DIAxW)	Weight	Reel Colour	Cord Colour
LE2630B14	30'	14/3 SJT	Triple Outlet	13A	9.25"x 3"	9.4 lbs	Black	Yellow
LE1340R	40'	16/3 SJTW	13W compact fluorescent light	N/A	9.25"x3"	9.0 lbs	White	Yellow
LE1740RLED	40'	18/2 SJTOW	LE1725LED LED work light	N/A	9.25"x3"	9.0 lbs	White	Yellow
LE2320CAT	20'	CAT6	2' CAT6 pigtail	N/A	6.5"x2"	4.0 lbs	Black	Grey

# Hand Wind Cord Reels

## LE7100 Series

### Heavy-Duty Reels



The 71000 Series cable reel is built to last a lifetime. Its heavy duty steel frame, rolled side discs, and powder painted exterior offer exceptional strength and durability.

It features four 120V 15/20A T-slot receptacles and 120V 15A plug. Receptacles are recessed for protection against impact and inadvertent contact, while the enclosed terminals at the center of the reel hub prevent users from contacting live connections. A circuit breaker protects against overloads and an LED illuminates to indicate that the reel is connected to power.

This reel can be configured with a variety of plugs, cord lengths, and cord types to meet your unique requirements.

**Approvals:**  
cULus Certified

Part No.	Cable Length	Cord Type	Outlet Rating	Weight
71000	10" pigtail, ready for winding your existing extension cord	N/A	N/A	11.0 lbs
7105012	50'	12/3 SOOW cord with plug	15A	15.8 lbs
7110012	100'	12/3 SOOW cord with plug	15A	20.6 lbs



# Portable Power & Accessories

Jobsites are rapidly evolving places that need to adapt to the changing environment, work at hand and safety requirements.

Lind's line of portable power devices will help you bring power where you need it, when you need it, in the safest way possible.

Temporary Power  
Distribution.....53

Extension Cords.....54

# Temporary Power Distribution

## 91000

### 50A Temporary Power Distribution Unit



The Temporary Power Distribution Unit is designed to safely distribute temporary power on jobsites. It's appropriate for outdoor use (NEMA 3R) and designed to stand up to the toughest workplaces. The 120V/20A receptacles are protected by individual GFCIs with power on indicators. The outlets also provide open neutral and reverse phasing protection.

The system uses a 50A California Standard power inlet that then distributes power to several receptacles (see below). Over current protection is provided by a full complement of circuit breakers located under the easy-access side panel.

#### Approvals:

cULus Certified

<b>91000</b>	Power distribution unit
<b>91006</b>	50' power cord for 9100. 6/3-8/1 SOW, 125-250V/50A
<b>91007</b>	100' power cord for 9100. 6/3-8/1 SOW, 125-250V/50A

*Receptacles* 6 x 120V/20A 5-20R

---

*Receptacles* 1 x 250V/30A L6-30R

---

*Receptacles* 1 x 50A California Standard (for linking units)

Custom units available. We can do higher power versions and different receptacle configurations. Call us with your requirements.

# Portable Power & Accessories

## Extension Cords

### Heavy-Duty



Lind's line of heavy-duty neoprene extension cords are designed to provide long life on the most demanding jobsites. With a thick 'cable' outer jacket and oil resistant inner insulation, the cord is designed to stay flexible even at extreme cold temperatures and to resist heated objects and oils. The product features a rugged nylon plug and connector.

**Approvals:**  
ESA Certified

Part No.	Cable Length	Cord Type	Cord Rating
LE16-25	25'	16/3 SOOW	13A
LE16-50	50'	16/3 SOOW	13A
LE16-100	100'	16/3 SOOW	10A
LE14-25	25'	14/3 SOOW	15A
LE14-50	50'	14/3 SOOW	15A
LE14-100	100'	14/3 SOOW	15A
LE12-25	25'	12/3 SOOW	15A
LE12-50	50'	12/3 SOOW	15A
LE12-100	100'	12/3 SOOW	15A

### Industrial



Our line of circuit breaker protected extension cords features a 15 amp circuit breaker that can be reset on the outlet head. The breaker helps protect the cord from equipment overload, which can cause electrical fires. We offer a triple-outlet T-head model.

**Approvals:**  
cULus Certified

Part No.	Outlets	Cable Length	Cord Type	Cord Rating
LE14-T6	3	6'	14/3 SJTW	15A
LE12-T100	3	100'	12/3 SJTW	15A
LE14-25CB	1	25'	14/3 SJTW	15A
LE14-50CB	1	50'	14/3 SJTW	15A



# Static Bonding & Grounding

Lind Equipment has the equipment you need to properly ground the apparatus and vehicles at your facility. Whether you are grounding containers, drums, railcars, tanker-trucks, marine vessels, or aircraft, we have the clamps, cables, reels and accessories to fit all your static bonding and grounding needs.

Smaller Heavy-Duty Hand Clamps.....	56
Larger Heavy-Duty Hand Clamps.....	57
Aviation Grounding Products.....	58
Heavy-Duty Assemblies.....	59
Straight Cable Assemblies.....	60
Pipe Clamps & C-Clamps.....	61
Static Monitoring.....	62
StaticSure Portable Monitoring.....	63-64
G2 Series Monitoring.....	65-66
Grounding Reels.....	67-70
Complementary Products.....	71

# Static Bonding & Grounding

## Smaller Heavy-Duty Hand Clamps

Bonding and grounding is the approved and best way to drain-off or neutralize static charges in drum storage areas; during truck, rail car, and barge transfers; and during aircraft fueling. Lind Equipment has the bonding and grounding products to help you in all of these situations. We offer a wide variety of grounding clamps to meet all static grounding and bonding applications. Whether you are designing a complete facility or have a one-time requirement, we can help.

### REB



- Cast aluminum construction with two hardened stainless steel points
- Industry standard for bonding and grounding containers, drums, totes, and machinery
- 55 lb spring pressure helps to ensure proper metal contact through paint and corrosion build-up
- FM approved
- Can take up to #6 cable
- Clamp opens to 5/8"

### VUD-100

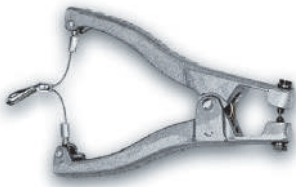

- Cast aluminum construction with two stainless steel points
- Special application clamp designed for drums with large, rolled rims
- Quick-release harness helps open the clamp when pulled by the cable, and minimizes strain on cable connection

### RSS



- Stainless steel construction with two stainless steel points and indented surface
- Excellent for grounding drums and other small vessels. Ideal for use in the pharmaceutical and food industries.
- Stamped stainless steel composition makes clamp light and easy to handle
- Can take up to #6 cable

### ALS10A

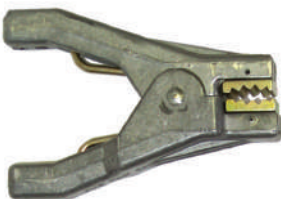

- Cast aluminum construction with plated steel jaws
- Aviation industry standard for bonding and grounding aircraft and refueling vehicles
- Ideal for attaching to landing gear, posts, ground balls, ground rods and other curved unpainted surfaces
- Complies with Mil Spec M83413/7-1
- Clamp opens to 13/16"
- Can take up to #6 cable

### ALS10B

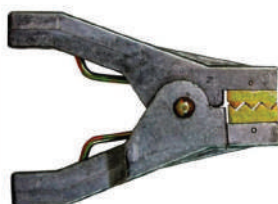

- Cast aluminum construction with plated steel jaws
- Intermeshing jaws are designed to attach to FIBC (Flexible Intermediate Bulk Containers)
- Engineered specifically to ground "Type C" Super Sacks
- Can take up to #6 cable



# Larger Heavy-Duty Hand Clamps

## GAT Clamp Series



- Cast aluminum construction, available with stainless steel points or brass "cup" points (for attachment to ground balls)
- Large, heavy-duty clamp designed for grounding railcars, tanker trucks, barges, and large vats
- Equipped with a quick release harness, designed to open the clamp automatically in case the operator forgets to detach the clamp prior to the vehicle's departure
- Clamp opens at 1 1/2"

• This GAT clamp comes in four configurations to meet your bonding and grounding requirements

### GAT-P

- Three stainless steel points (one on one side, two on other side).
- Accepts cables 3/32" - 3/8" O.D. (maximum #2 cable size)

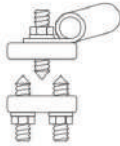

### GAT-PIP

- GAT-P with isolated stainless steel point on one side, for all metal surfaces

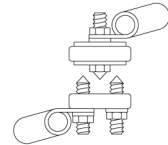

### GAT-PIP1

- GAT-P with isolated brass "cup" point on one side, fits ground balls, as well as metal surfaces

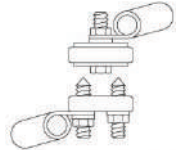

### GAT-PIP2

- Two isolated brass "cup" points (one on each side). Ideal for ground ball applications

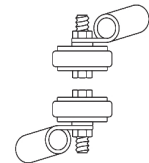

## G40 Clamp Series



- Cast bronze construction, available with stainless steel points or brass "cup" points (for attachment to ground balls)
- Large, rugged clamp designed for grounding railcars, tanker trucks, barges, and large vats
- Equipped with a quick release harness, so tension will force the clamp to release automatically if it has not been manually removed prior to vehicle departure
- Clamp opens to 1 1/4"

• This G40 clamp comes in four configurations to meet your bonding and grounding requirements

### G40-PCU

- Accepts cables 3/16" - 3/8" O.D. (maximum #2 cable size)
- Three stainless steel points (one on one side, two on other side), as well as grooves to allow for ground ball connection



### G40-PM

- Accepts cables 1/4" O.D. (maximum #6 cable size).
- Three stainless steel points (one on one side, two on other side)



### G40-PMIP

- G40-PM with isolated stainless steel point on one side

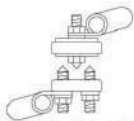

### G40-PMIP1

- G40-PM with isolated brass "cup" point on one side, fits ground balls

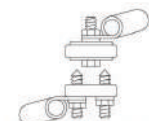

# Static Bonding & Grounding

## Aviation Grounding Products

Our line of aviation grounding products includes a variety of bayonet plugs, aircraft grounding clamps, assemblies, and specialty coated cables that are highly visible on the tarmac and hangar floor. We also offer bonding and grounding products to meet military specifications for the refueling and maintenance of aircraft.

### ALS10A



- Cast aluminum construction with plated steel jaws
- Aviation industry standard for bonding and grounding aircraft and refueling vehicles
- Ideal for attaching to landing gear, posts, ground balls, ground rods and other curved unpainted surfaces
- Complies with Mil Spec M83413/7-1

### 110-G AVIATION GROUND CLAMP



- Plated steel construction
- Special application clamp, intended for attachment to recessed ground balls (ground wells) found in hangars and on tarmacs
- With safety in mind, the 110-G is designed to lie flat to minimize any tripping hazard, and will not be dislodged by vehicular traffic

### AV65 AVIATION BAYONET PLUG



- Stainless steel, hexagonal shape construction
- For use with standard aircraft grounding receptacles
- Provides a secure bonding and grounding connection
- Complies with Mil Spec M83413/4-1

**Knurled version also available P/N: AV65KN**

### AV75 AVIATION BAYONET PLUG



- Solid brass construction with hexagonally shape body
- For use with standard aircraft grounding receptacles
- Provides a secure bonding and grounding connection

### G12 GROUND BALL



- Brass construction
- Ideal for use with re-fueler, tanker, and vacuum trucks/trailers
- 5/8" diameter ground ball, with standard 3/8"-16 threaded stem

# Heavy-Duty Assemblies

**If you don't see what you need here, no problem!** We can change any of the assemblies to include the length or clamp type that you require. Chances are we have already made it in the past, and if not, we are happy to discuss and create the custom solution that fits your application.

If you are uncomfortable designing a static grounding system by yourself, we can assist with a "Site Survey" assessment to help you determine the best way to provide bonding and grounding in your workplace.

## Retractable Assemblies



Eliminate tangled bonding and grounding assemblies that lie on the floor and present a tripping hazard. Coiled assemblies neatly and compactly retract out of the way when not in use. The coiled plated steel cable is bright orange PVC coated for high visibility.

Part No.	Length	Size	O.D.	Termination 1	Termination 2
<b>RAC5</b>	5'	1/8"	3/16"	REB hand clamp	5/16" lug terminal
<b>RAC10</b>	10'	1/8"	3/16"	REB hand clamp	5/16" lug terminal
<b>RAC15</b>	15'	1/8"	3/16"	REB hand clamp	5/16" lug terminal
<b>RAC1010</b>	20'	1/8"	3/16"	REB hand clamp	5/16" lug terminal
<b>RAC30</b>	30'	1/8"	3/16"	REB hand clamp	5/16" lug terminal
<b>RAC20</b>	20'	3/16"	1/4"	GAT-P large aluminum hand clamp	3/8" lug terminal
<b>RAC20B</b>	20'	3/16"	1/4"	G40 large bronze hand clamp	3/8" lug terminal

## Aviation Assemblies



Part No.	Cable	Termination 1	Termination 2
<b>AV50GW</b>	50' of 3/32" plated steel cable, yellow PVC coated to 5/32" O.D.	ALS10A with anti-snag wye	ALS10A with anti-snag wye
<b>AV50AP</b>	50' of 3/32" plated steel cable, yellow PVC coated to 5/32" O.D.	ALS10A with anti-snag wye	ALS10A with anti-snag wye

# Static Bonding & Grounding





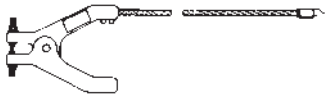
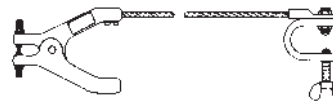
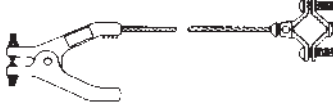

## Straight Cable Assemblies

For any assembly that comes with a standard 3' length add -72 to the part number to change the length to a 6' cable, or -120 for 10' cable. Please contact one of our sales representatives for assistance with other custom lengths.

### LE60 Assemblies Heavy-Duty

Part No.	Cable	Termination 1	Termination 2
LE60HH 	3' of 1/8" plated steel cable	REB hand clamp	REB hand clamp
LE60HCS 	3' of 1/8" plated steel cable	REB hand clamp	EP-1, 3/4" C-clamp
LE60HL 	3' of 1/8" plated steel cable	REB hand clamp	5/16" lug terminal
LE60HCL 	3' of 1/8" plated steel cable	REB hand clamp	EP-4, 1 1/2" C-clamp
LE60HP 	3' of 1/8" plated steel cable	REB hand clamp	Bronze pipe clamp (fits 1/2" to 1" pipe)

### LE Assemblies Industrial

Part No.	Cable	Termination 1	Termination 2
LE62 	3' of 1/8" plated steel cable	LE-25C alligator clip, opens 3/4"	LE-25C alligator clip, opens 3/4"
LE63 	3' of 1/8" plated steel cable	LE-25C alligator clip, opens 3/4"	5/16" Copper Lug Terminal
LE64 	3' of 1/8" plated steel cable	LE-25C alligator clip, opens 3/4"	EP-1 3/4" C-clamp
LE70 	3' of 1/8" plated steel cable	5/16" copper lug terminal	5/16" copper lug terminal
LE72 	3' of 3/32" PVC coated cable	LE-25C alligator clip, opens 3/4"	LE-25C alligator clip, opens 3/4"
LE79 	3' of 3/32" PVC coated cable	LE-25C alligator clip, opens 3/4"	EP-1 3/4" C-clamp

# Pipe Clamps & C-Clamps

## Heavy-Duty Pipe Clamps



- Cast bronze construction adjustable pipe clamps
- Rugged design for semi-permanent connections

Part No.	Pipe Range (I.D.)	Min. Pipe O.D.	Max. Pipe O.D.
JR-150-6	1/2" to 1"	5/8"	1 3/8"
JR-150-7	1 1/4" to 2"	1 3/8"	2 3/8"
JR-150-30	2" to 4"	2 1/8"	4 1/2"
JR-150-50	4 1/2" to 6"	4"	6 5/16"

## Heavy-Duty C-Clamps

- Plated steel, cast bronze and malleable iron constructions
- Designed for easy, semi-permanent connections for various static grounding applications

Part No.	Description	Part No.	Description
EP-1	<ul style="list-style-type: none"> <li>• Plated Steel</li> <li>• Small clamp with stainless steel point; opens to 3/4"</li> <li>• For bonding drums to drum racks</li> </ul>	EP-4	<ul style="list-style-type: none"> <li>• Plated Steel</li> <li>• Large clamp with steel point; opens to 1 1/2"</li> <li>• Larger version of EP-1</li> </ul>
EP-2	<ul style="list-style-type: none"> <li>• Zinc Plated Malleable Iron</li> <li>• 1" beam clamp</li> <li>• Low cost alternative to EP-1</li> </ul>	EP-5	<ul style="list-style-type: none"> <li>• Plated Steel</li> <li>• Large clamp with steel point; opens to 1 1/2"</li> <li>• Larger version of EP-1</li> </ul>
EP-3	<ul style="list-style-type: none"> <li>• Cast Bronze</li> <li>• Large clamp; opens to 1 1/4"</li> <li>• For larger drums and vessels</li> </ul>	2178	<ul style="list-style-type: none"> <li>• Cast Bronze</li> <li>• Oversized clamp; opens to 2 1/2"</li> <li>• For marine vessels/ rail cars</li> </ul>

# Static Bonding & Grounding

## Static Monitoring

### What is it?

Static monitoring systems will warn an operator if they have not properly set up their equipment to drain static electricity.

Lind Equipment's static monitoring systems use sophisticated technology to sense the circuit from the equipment to ground and determine if the circuit is ready to safely drain static electricity.

### Why Do We Need It?

The movement of flammable material generates static electricity and if not properly controlled, this static can discharge in a hazardous location and cause an explosion or fire.

Lind's line of static grounding clamps, reels, and assemblies are designed to properly and effectively drain static electricity from equipment. However, it is almost impossible for an operator to know with certainty that they have properly grounded a piece of equipment to drain static.

You cannot see, hear, or sense static electricity until a static spark, or discharge, happens. This is too late, of course, as that spark could ignite the flammable materials in the area.

### Static Monitoring Systems

Facilities and corporations also benefit through the peace of mind that every transfer of flammables has been verified by one of Lind's static monitoring systems, thus protecting their workers and equipment even when contractors are performing these operations on site.

Lind's static monitoring systems - the G2 series of fixed, mounted units that can be interlocked with pumping systems, and the StaticSure series of portable monitoring units that can be brought anywhere that a transfer of flammables happen.

# StaticSure Portable Monitoring System

## LE600i StaticSure

StaticSure is an intrinsically safe portable static monitoring device designed to help you comply with safety regulations and maintain a safe working environment. When used with proper bonding and grounding clamps and cables, StaticSure helps to ensure that a static bond has been achieved prior to handling flammable materials.

The device is self-powered and works by constantly measuring the resistance between its end points to ensure that proper bonding is being achieved. The device can be used to either provide the static electricity with a path to a known ground point such as a ground bus, or to provide a bond between two objects that allows the electricity potential to equalize, thus reducing the risk of static discharge between the two objects.

StaticSure will illuminate a bright red LED if there is **NOT** a good connection between the clamp and the ground point, instantly alerting the operator to the danger and allow them to fix the static ground prior to transferring flammables.

**Approvals:** cULus hazardous locations Class I, Division 1, Group A, B, C and D and Class II, Division 1, Groups F and G



Temperature Code:	T4
Ambient Temperature (Ta):	-40C <= Ta <= +50C    -40F <= Ta <= +122F
Resistance Setting:	5 Ohms
Life Expectancy:	The battery is designed to last for approximately 4-5 years based on average industry usage parameters
Environmental Rating:	IP65

### Reel Mounted SKUs:

StaticSure is now available on a custom length, heavy duty cord reel which is ideal for truck and railcar loading/unloading, aircraft fueling and vacuum truck operations.

Popular SKUs	Description	Application
LE9050163SSG	50' heavy-duty NEMA4 reel with LE600i and a GAT-PIP clamp on the retractable end	Mounting to a vac truck or bulk liquid truck where long runs of cord are necessary to reach the known ground point
LE95100163SSG	100' heavy-duty NEMA4X reel with LE600i and a GAT-PIP clamp on the retractable end	Mounting to a vac truck or bulk liquid truck where long runs of cord are necessary to reach the known ground point
LE9050163SSR	50' heavy-duty NEMA4 reel with LE600i and a REB-IP clamp on the retractable end	Mounting in a facility where long runs of cord are necessary to reach the equipment that needs to be grounded
LE95100163SSR	100' heavy-duty NEMA4X reel with LE600i and a REB-IP clamp on the retractable end	Mounting in a facility where long runs of cord are necessary to reach the equipment that needs to be grounded

# Static Bonding & Grounding

## StaticSure Portable Monitoring System

### Portable StaticSure SKUs

Below is a list of the SKUs that are built for the most common static bonding and grounding applications. Other hand clamps and cable combinations are available, as are replacement units or cords.

#### LE600-20CG-2SL

- 20' 18/2 SOW coiled cord with GAT-PIP clamp
- LE600i portable static monitoring unit
- 2' 18/2 SOW cord with lugs

Grounding trucks, railcars or other larger objects with the larger GAT-IP clamp where it is desirable to have the StaticSure unit mounted permanently to a wall/post. Use where the mounted StaticSure device will always be visible from the point where the clamp is attached to the grounded object.

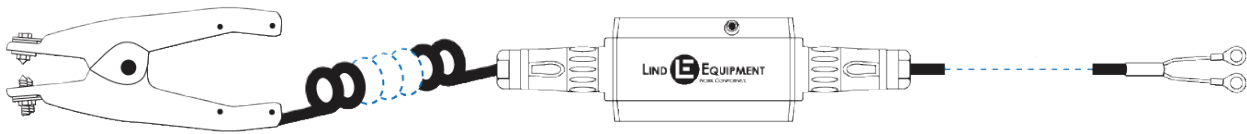

#### LE600-20CR-2SL

- 20' 18/2 SOW coiled cord with REB-IP clamp
- LE600i portable static monitoring unit
- 2' 18/2 SOW cord with lugs

Grounding drums, barrels or other smaller portable objects with the smaller REB-IP clamp where it is desirable to have the StaticSure unit mounted permanently to a wall/post. Use where the mounted StaticSure device will always be visible from the point where the clamp is attached to the grounded object (e.g. indoor operations in a drumming room).

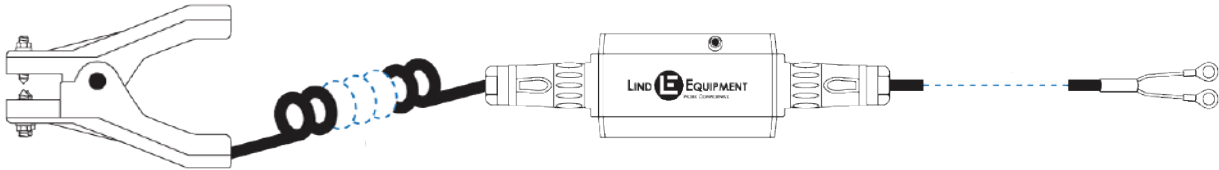

#### LE600-20CG-2SG

- 20' 18/2 SOW coiled cord with GAT-PIP clamp
- LE600i portable static monitoring unit
- 2' 18/2 SOW straight cord with GAT-PIP clamp

Truly mobile solution for grounding trucks, railcars or other larger objects with the larger GAT-IP clamp. Use where the StaticSure will be moved around to a wide variety of potential grounding spots and a mounted unit would not be feasible.



#### LE600-20CR-2SR

- 20' 18/2 SOW coiled cord with REB-IP clamp
- LE600i portable static monitoring unit
- 2' 18/2 SOW straight cord with REB-IP clamp

Truly mobile solution for grounding drums, barrels, or other smaller objects with the smaller REB-IP clamp. Use where the StaticSure will be moved around to a wide variety of potential grounding spots and a mounted unit would not be feasible.

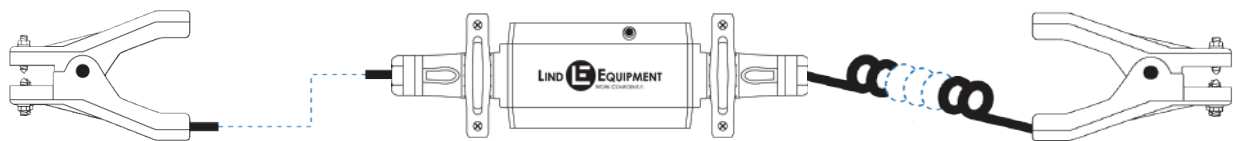



# G2 Series Monitoring System

## G2 Series Ground Monitoring

The G2 Series is a wall mounted unit that provides a positive ground indication through the use of an intrinsically safe monitoring circuit driving a switching relay. Upon connection of the self-releasing clamp and cable to a conducting material (such as a truck), the intrinsically safe circuit is completed and the operator will be shown a green light to indicate that a ground connection has been established.

While most competing systems only monitor the path from the ground unit to the clamp, the G2 series also employs a segregated cable connection to actual ground, which is also monitored for low resistance. An interruption in either path (indicated by resistance above 5 ohms) will shut down the system.

The system can also be interlocked with filling equipment to ensure that no flammable product can be transferred until the ground is established. If the circuit is broken by release of the grounding clamp or other ground interruption, the control relay will open and a red light will be displayed. Any filling equipment that is controlled by the system will also be halted until the ground is re-established.

The G2 Series systems will do the following: shut down a pump or valve; sound an alarm; show a red light when conditions are unsafe; show a green light when conditions are safe; open contacts on a computer; indicate that static path to ground has integrity and receive permissive signals from a computer control.

Standard options include a choice of aluminum or bronze clamp, straight or self-coiling cord, and a variety of cord storage and retracting reels.

**Approvals:** cULus Class I, Division 1, Group D and Class II, Groups E, F and G

## G2 System with GAT Clamp



- 5 Ohm set resistance point
- Unit measures 13" H x 11" W x 5" D
- 110V power required, 3/4" NPT connection. (220V available)
- Moisture drain

Part Number	Clamp	Cord
<b>G2-25IG-A2</b>	Aluminum GAT-PIP2	25' straight SOOW cord
<b>G2-25IG-A2CC</b>	Aluminum GAT-PIP2	25' coiled SEOOW cord
<b>G2-50IG-A2RL</b>	Aluminum GAT-PIP2	LE9000 reel (see page 45) with 50' 16/2 SOW cord
<b>G2-100IG-A2RL</b>	Aluminum GAT-PIP2	LE9500 reel (see page 46) with 100' 16/2 SOW cord

All units with reels come with 25' cord between reel and G2 system. Call for custom lengths.

# Static Bonding & Grounding

## G2 Series Monitoring System

### G2 System with G40 Clamp



- 5 Ohm set resistance point
- Unit measures 13" H x 11" W x 5" D
- 110V power required, 3/4" NPT connection (220V available)
- Moisture drain

Part Number	Clamp	Cord
<b>G2-25IG-B1</b>	Bronze G40-PMIP1	25' straight SOOW cord
<b>G2-25IG-B1CC</b>	Bronze G40-PMIP1	25' coiled SEOOW cord
<b>G2-50IG-B1RL</b>	Bronze G40-PMIP1	LE9000 reel (see page 45) with 50' 16/2 SOW cord
<b>G2-100IG-B1RL</b>	Bronze G40-PMIP1	LE9500 reel (see page 46) with 100' 16/2 SOW cord

All units with reels come with 25' cord between reel and G2 system. Call for custom lengths.

### G2 Deadman Monitoring

The G2 Series Electronic Ground Indicating Systems can be used as a Deadman System with a deadman switch in place of the ground clamp. When the operator depresses the switch, the intrinsically safe monitoring circuit drives a switching relay that can, for instance, switch on a pump and initiate product flow. If the operator releases the switch at any time, the relay opens and product flow is immediately stopped.

Options include red and green indicating lights, coiled cord, and a variety of cord storage and retracting reels. Deadman switch is included with all SKUs.

**Approvals:** cULus Class I, Division 1, Group D and Class II, Groups E, F and G



Part Number	Indicating Lights	Cord
<b>G2-25IG-DM</b>	Yes	25' straight SOOW cord
<b>G2-50IG-DM</b>	Yes	50' straight SOOW cord
<b>G2-25IG-DMNL</b>	No	25' straight SOOW cord
<b>G2-50IG-DMNL</b>	No	50' straight SOOW cord
<b>G2-50IG-DMRL</b>	Yes	LE9000 reel (see page 45) w/ 50' 16/2 SOW cord
<b>G2-100IG-DMRL</b>	Yes	LE9500 reel (see page 46) w/ 100' 16/2 SOW cord

# Self-Braking Auto Rewind Grounding Reels

## ML2930 Series

Heavy-Duty  
Self-Braking



The ML2930 Series are very ruggedly constructed to withstand the toughest environments. Their open-style design seals all the mechanical parts in an internal gasketed chamber. This prevents dirt and moisture on the cable from reaching the mechanical parts inside.

A latching mechanism holds the cable at any desired length. A slight pull on the cable releases the mechanism causing retraction. A ball and adjustable cable stop on the cable assembly keep the cable end within easy reach. The standard models include the LE-21C alligator clamp.

Our heavy-duty static grounding/bonding reels offer steel components and a cantilever-type frame, which support the reel assembly, and are designed to function under the most adverse conditions. Maintenance and repairs are made possible by bolt-together construction.

<i>Standard Clamp:</i>	100 amp solid copper alligator clip (LE-21C)
<i>Electrical Resistance:</i>	5 ohms maximum between clamp and mounting base
<i>Finish:</i>	Red enamel
<i>Special Feature:</i>	Braking system governing cable retraction speed

Part Number	Cable Length	Cable Size	Cable Type	Weight
<b>ML2930-46</b>	50'	3/32" ID coated to 1/8" OD	Clear PVC coated plated steel	14.7 lbs
<b>ML2930-46YH</b>	50'	3/32" I.D. coated to 5/32" OD	Yellow Hytrel® coated plated steel	15.0 lbs
<b>ML2930-9</b>	75'	3/32" ID coated to 1/8" OD	Clear PVC coated plated steel	17.9 lbs
<b>ML2930-9YH</b>	75'	3/32" ID coated to 5/32" OD	Yellow Hytrel coated plated steel	18.2 lbs
<b>ML3416-7</b>	100'	3/32" ID coated to 1/8" OD	Clear PVC coated plated steel	23.0 lbs
<b>ML3416-7YH</b>	100'	3/32" ID coated to 5/32" OD	Yellow Hytrel coated plated steel	23.4 lbs

Substitute the LE21C Alligator Clip for our heavier duty REB Clamp when using this reel in outdoor areas or with painted, dirty or rusty surfaces. Add "REB" to the end of the part number.



**Need a different clamp? Need a specialized wye? We can do customized static ground reels.**

# Static Bonding & Grounding

## Auto Rewind Grounding Reels

### ML2930 Series

Heavy-Duty



The Lind Equipment heavy-duty reels offer a robust, gasketed design in a lower cost, riveted construction. Priced very reasonably, providing a viable alternative to manual rewind reels, yet offering the benefit of automatic self-retraction of the cable. Clamps should be walked back to the reel during retraction. These reels meet MIL-PRF A-A-50696 for use in military deployments.

<i>Standard Clamp:</i>	100 amp solid copper alligator clip (LE-21C)
<i>Electrical Resistance:</i>	5 ohms maximum between clamp and mounting base
<i>Finish:</i>	Red enamel

Part Number	Cable Length	Cable Size	Cable Type	Weight
<b>ML2930-C50</b>	50'	3/32" ID coated to 1/8" OD	Clear PVC coated plated steel	12.0 lbs
<b>ML2930-Y50</b>	50'	3/32" I.D. coated to 5/32" OD	Yellow Hytrel® coated plated steel	12.3 lbs
<b>ML2930-C75</b>	75'	3/32" ID coated to 1/8" OD	Clear PVC coated plated steel	13.5 lbs
<b>ML2930-Y75</b>	75'	3/32" ID coated to 5/32" OD	Yellow Hytrel coated plated steel	13.8 lbs
<b>ML3416-C100</b>	100'	3/32" ID coated to 1/8" OD	Clear PVC coated plated steel	17.0 lbs
<b>ML3416-Y100</b>	100'	3/32" ID coated to 5/32" OD	Yellow Hytrel coated plated steel	17.3 lbs

Substitute the LE21C Alligator Clip for our heavier duty REB Clamp when using this reel in outdoor areas or with painted, dirty or rusty surfaces. Add "REB" to the end of the part number.

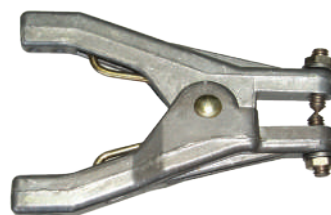

**Need a different clamp? Need a specialized wye? We can do customized static ground reels.**

# Hand-Wind Grounding Reels

## ML2930 Series

Heavy-Duty  
Hand-Wind



These ruggedly constructed reels are an economical alternative to automatic retracting reels. In addition to lower initial cost, there are fewer parts to maintain, allowing for years of trouble-free service. ML2930 series hand-wind reels also offer highly compact storage of a wide range of cable lengths up to 150'.

<i>Standard Clamp:</i>	100 amp solid copper alligator clip (LE-21C)
<i>Electrical Resistance:</i>	5 ohms maximum between clamp and mounting base
<i>Finish:</i>	Yellow enamel
<i>Capacity:</i>	125' with 5/32" O.D. cable, 150' with 1/8" O.D. cable

Part Number	Cable Length	Cable Size	Cable Type	Weight
<b>ML2930-MC50</b>	50'	3/32" ID coated to 1/8" OD	Clear PVC coated plated steel	9.5 lbs
<b>ML2930-MY50</b>	50'	3/32" I.D. coated to 5/32" OD	Yellow Hytrel® coated plated steel	9.8 lbs
<b>ML2930-MC75</b>	75'	3/32" ID coated to 1/8" OD	Clear PVC coated plated steel	10.0 lbs
<b>ML2930-MY75</b>	75'	3/32" ID coated to 5/32" OD	Yellow Hytrel coated plated steel	10.3 lbs
<b>ML2930-MC100</b>	100'	3/32" ID coated to 1/8" OD	Clear PVC coated plated steel	10.5 lbs
<b>ML2930-MY100</b>	100'	3/32" ID coated to 5/32" OD	Yellow Hytrel coated plated steel	10.8 lbs
<b>ML2930-MC125</b>	125'	3/32" ID coated to 1/8" OD	Clear PVC coated plated steel	11.0 lbs
<b>ML2930-MY125</b>	125'	3/32" ID coated to 5/32" OD	Yellow Hytrel coated plated steel	11.3 lbs
<b>ML2930-MC150</b>	150'	3/32" ID coated to 1/8" OD	Clear PVC coated plated steel	11.5 lbs

Substitute the LE21C Alligator Clip for our heavier duty REB Clamp when using this reel in outdoor areas or with painted, dirty or rusty surfaces. Add "REB" to the end of the part number.

**Need a different clamp? Need a specialized wye? We can do customized static ground reels.**

# Static Bonding & Grounding

## ROTA Auto Rewind Grounding Reels

### Industrial Series

Rota-Reel grounding reels are compact and lightweight. Their enclosed design is best suited to cabinet/indoor installations, and applications where a low-cost reel is needed.

Now available in stainless steel versions (200-20RST/700-50RST) for clean applications such as pharmaceuticals.

**700-50R**



**700-50R-ST/200-20R-ST**



Part Number	Cable Length	Cable Size	Cable Type	Clamp & Weight
<b>200-20R</b>	20'	3/32" O.D.	Plated Steel	LE21C Alligator Clip WEIGHT: 3.2 lbs
<b>700-50R</b>	50'	3/32" O.D.	Plated Steel	LE21C Alligator Clip WEIGHT: 5.5 lbs
<b>700-50R-NC</b>	50'	1/16" I.D. coated to 3/32" O.D.	Clear PVC coated plated steel	LE21C Alligator Clip WEIGHT: 5.5 lbs
<b>200-20R-ST</b>	20'	3/32" O.D.	Stainless steel	Stainless Steel Alligator Clip WEIGHT: 3.2 lbs
<b>700-50R-ST</b>	50'	3/32" O.D.	Stainless steel	Stainless Steel Alligator Clip WEIGHT: 3.2 lbs

**R-50R**



Part Number	Cable Length	Cable Size	Cable Type	Clamp & Weight
<b>R-20R</b>	20'	3/32" O.D.	Plated Steel	REB Hand Clamp WEIGHT: 3.5 lbs
<b>R-50R</b>	50'	3/32" O.D.	Plated Steel	REB Hand Clamp WEIGHT: 5.7 lbs

# Complementary Products

## Portable Static Bonding & Grounding Kit

LE-ERK1



Accidents such as fuel tanker rollovers need to be properly grounded in order to allow for the removal of the flammable fuel from one tanker to another. The LE-ERK1 portable static bonding and grounding kit allows for a Hazmat team to have a portable, easy to set-up kit containing all the necessary items to eliminate the static discharge from an accident scene in a transportable, rugged container.

### Equipped With:

- Copper mobile ground stake
- Sectional hammer driver for easy insertion and removal of ground rods
- 2 grounding assemblies with 20' of 3/16" orange PVC coated coiled cable, aluminum ground clamp, and a copper lug
- Hard plastic water-tight case with foam

## Water & Gasoline Paste



Water level indicating paste shows exactly how much water is present in your fuel storage tank, enabling you to pump out the precise amount from the tank. If the paste colour does not change, you can feel confident that no water is present in your tank.

Modified water paste has been designed for use in methanol and ethanol enriched fuels, including those with DEGMME fuel system icing inhibitors (FSII). Alcohols are soluble in fuels in all proportions when they are water free but relatively small amounts of water can cause separation of alcohol from the fuel. The mixture settling to the bottom of the storage tank is predominately alcohol and cannot be detected by normal water detection paste.

Gasoline level indicator paste ensures a highly accurate reading when gauging gasoline storage tanks. Simply spread a thin coating on a tape or gauge rod where liquid is likely to appear before lowering it into a tank. A sharp line of demarcation at the product interface is instantly shown. Works with gasoline, diesel, naphtho, kerosene, gas oil, crude oil, jet fuels, and other hydrocarbons.

Part No.	Description	Colour Change	Package
LEMW	McCabe Water Paste	Green to Red	3 oz. jar
LEKW	Kolor Kut Water Paste	Golden Brown to Red	3 oz. tube
LEKMW	Kolor Kut Modified Water Paste for regular and oxygenated fuels (Methanol, Ethanol, MTBE, Ether, etc.)	Varies depending upon fuel; see literature enclosed with product	2.5 oz. tube
LEKG	Kolor Kut Gas Paste	Light Pink to Red	2.25 oz. jar



# GFCIs

Ground faults can occur when electrical current is diverted from its normal circuit to ground due to water infiltration or damage to cords or equipment. Even a relatively minor ground fault has the potential to be lethal.

A GFCI device monitors the electrical current leaving and returning to the GFCI. If there is a difference of as little as 4-6mA of current flow, the GFCI will 'trip', cutting off the flow of electricity. This trip happens in a fraction of a second, and can save lives and protect your equipment.

GFCI Plug & Cord Sets.....	73
Inline GFCI Plug & Cord Sets....	74
Three Receptacle GFCIs.....	75
GFCI Quad Box Sets.....	76
User Attachable GFCIs.....	77
High Powered GFCIs.....	78
High Powered ELCIs.....	79



## GFCI Plug & Cord Sets

These portable GFCIs are durable enough to be **used both indoors and outdoors** on the toughest work environments. Rainproof rated and listed for outdoor use, these are the units you need for ground-fault protection on the job site.

### 14650Y Single Outlet GFCI Plug and Adapter



Provides GFCI protection for tools used indoors. Comes with booted buttons. Good for indoor and outdoor use.

**Approvals:** CSA and UL Certified

- Reset: Manual
- Volts/Amps: 120V/15A
- Trip Level: 4-6mA

### 14880 Series GFCI Plug and Cord Set



GFCI plug and cord set that plugs into an outlet and provides between 9" and 50' of cord with female receptacle end. Good for indoor and outdoor use.

**Approvals:** cULus Certified

- Reset: Manual
- Volts/Amps: 120V/15A
- Trip Level: 4-6mA
- Cord Type: SJTW yellow cord

Part Number	Cord Length & Type
14880-4001	9" 14/3 cord
14880-4006	6' of 14/3 cord
14880-4025	25' of 14/3 cable
14880-4050	50' of 14/3 cable
14880-2001	9" of 12/3 cable
14880-2006	6' of 12/3 cable
14880-2025	25' of 12/3 cable
14880-2050	50' of 12/3 cable

**Custom cord sets are also available. Call us with your specifications.**

## Inline GFCI Plug & Cord Sets

### 26020L Series Inline GFCI Plug and Cord Set



Inline GFCI cord set for providing rugged, portable GFCI protection to cord sets and equipment. Great for industrial plant maintenance, equipment service and construction site applications. Indicator light on unit displays when there is power on. Good for indoor and outdoor use.

**Approvals:** cULus Certified

- Reset: Manual
- Volts/Amps: 120V/15A
- Trip Level: 4-6mA
- Cord Type: SJTW yellow cord

Part Number	Cord Length & Type
26020L-2001	14" of 12/3 cable
26020L-2006	6' of 12/3 cable
26020L-2025	25' of 12/3 cable
26020L-2050	50' of 12/3 cable

### 25080L Series Inline GFCI Plug and Cord Set



These units handle 20A of power on tough 12/3 cord. Features a power indicator light and between 14" and 25' of cord. Good for indoor and outdoor use.

**Approvals:** cULus Certified

- Reset: Manual
- Volts/Amps: 120V/15A
- Trip Level: 4-6mA
- Cord Type: 12/3 SJTW yellow

Part Number	Cord Length & Type
25080L-2001	14" of 12/3 cable
25080L-2006	6' 12/3 cord
25080L-2025	25' 12/3 cord
25080L-2002L	2' 12/3 cord, twist-lock connectors

**Custom cord sets are also available. Call us with your specifications.**

# Three Receptacle GFCI Plug & Cord Sets

## 14880TC Series



GFCI plug and cord set includes a heavy-duty molded T-head with three receptacles. Ideal for rugged, outdoor environments.

**Approvals:** cULus Certified

- Reset: Manual
- Volts/Amps: 120V/15A
- Trip Level: 4-6mA

Part Number	Cord Length & Type
14880TC-2502	2' 12/3 cord
14880TC-2506	6' 12/3 cord
14880TC-2525	25' 12/3 cord
14880TC-2550	50' 12/3 cord

## 26020TC Series Inline



The inline GFCI version of the T-head 14880TC. Molded T-head with three receptacles, and 12/3 SJTW cord. Good for indoor and outdoor use.

**Approvals:** cULus Certified

- Reset: Manual
- Volts/Amps: 120V/15A
- Trip Level: 4-6mA

Part Number	Cord Length & Type
26020TC-2503	2' 12/3 cord
26020TC-2525	25' 12/3 cord
26020TC-2550	50' 12/3 cord

Custom cord sets are also available. Call us with your specifications.

# GFCIs

## GFCI Quad Box Sets

### 14880 Quad Series

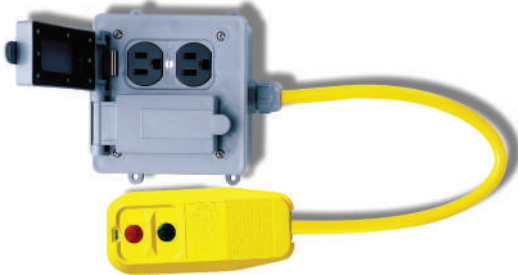

GFCI plug and quad box set with circuit breaker built into the box for convenient overload protection. Spring loaded covers protect each pair of receptacles on this impact resistant polymer box. Good for indoor and outdoor use. 12/3 SJTW cord comes in lengths between 2' and 50'.

**Approvals:** cULus Certified

- Reset: Manual
- Volts/Amps: 120V/15A
- Trip Level: 4-6mA

Part Number	Cord Length & Type
14880-2402	2' 12/3 cord
14880-2406	6' 12/3 cord
14880-2425	25' 12/3 cord
14880-2450	50' 12/3 cord

### 26020L & 25080L Quad Series Inline

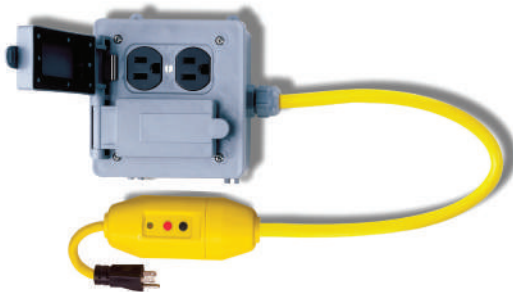

The inline GFCI version of our 14880 quad boxes, these units offer convenient safe power distribution for heavy power users. GFCI has lighted power-on indicator. Good for indoor and outdoor use. Units come in both 15A and 20A versions and have 12/3 SJTW cord.

**Approvals:** cULus Certified

- Reset: Manual
- Volts/Amps: 120V/15A (26020L models),  
120V/20A (25080L models)
- Trip Level: 4-6mA

Part Number	Cord Length & Type
26020L-2406	6' of 12/3 cord
26020L-2425	25' of 12/3 cord
25080L-2406	6' of 12/3 cord
25080L-2425	25' of 12/3 cord

**Custom cord sets are also available. Call us with your specifications.**

# User Attachables GFCI

## GFCI Plugs



Simply remove the existing plug from the cord, and attach the GFCI plug in its place. Accepts up to 12/3 SJ-type cords, or 14/3 S-type cords.

**Approvals:** cULus Certified

Part Number	Features
35190	User attachable GFCI plug, 120V/15A, 4 - 6 mA trip level, Auto reset
14880R	User attachable GFCI plug, 120V/15A, 4 - 6 mA trip level, Manual reset
24230	User attachable ELCI plug, 120V/15A, 10mA trip level, Auto reset

## GFCI Inline



25000L unit automatically senses input voltage, which allows use at 120V or 240V. Other models operate on either 120V or 240V (see descriptions). All units have a lighted power-on indicator. Accepts up to 12/3 SJ-type cords, or 14/3 S-type cords.

**Approvals:** cULus Certified

- Reset: Manual
- Volts/Amps: 120V/15A
- Trip Level: 4-6mA

Part Number	Cord Length & Type
25000	Dual-voltage 120V/20A and 240V/20A
25230	120V/20A

Custom cord sets are also available. Call us with your specifications.

## High Powered GFCIs & ELCIs

### 30 Amp High-Powered GFCIs

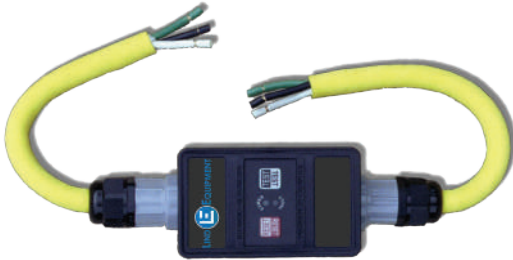

Pre-set trip levels and two feet line and load cord, these units support single phase power across a range of voltages. Dual LED indication lights display power and fault status. All units are automatic reset and NEMA 4X rated. Manual reset versions available upon request.

**Approvals:** cCSAus Certified

- Frequency: 60Hz
- Cable Configuration: 2' Yellow, SJEOOW cable, bare ends
- Response Time: 25mS max at 500 ohm fault
- Operating Temperature: -35°C to 66°C
- Reset Type: Automatic (manual reset available upon request)
- Enclosure: NEMA 4X and 6P wet location rated
- Switching Interface: Double insulated and recessed

Part Number	Volts/Amps	Cord Line & Load	Phase	Trip Level
<b>LECI-301201</b>	120V/30A	2' of 10/3 cord	1 $\emptyset$	6mA
<b>LECI-302083</b>	208V/30A	2' of 10/4 cord	3 $\emptyset$	6mA
<b>LECI-302403</b>	240V/30A	2' of 10/4 cord	3 $\emptyset$	6mA

# High-Powered ELCs

## LECI Series



Our higher-powered ELCs offer an unparalleled flexibility to meet your needs. With two different amprated units (40A and 60A) and a wide variety of operating voltages (120/208/240/480/600), There is a unit that will work for you.

Trip levels are selectable on the unit to offer the maximum protection while minimizing nuisance tripping. Automatic and manual reset modes are also selectable on the unit.

**Approvals:** cCSAus Certified

- Frequency: 60Hz
- Response Time: 25mS max at 500 ohm fault
- Operating Temperature: -35°C to 66°C
- Reset Type: Field selectable – automatic or manual reset
- Enclosure: NEMA 4X wet location rated
- Switching Interface: Double insulated and recessed

Part Number	Volts/Amp	Cord Line & Load	Phase	Trip Levels
LECI-601201	120V/60A	6' of 6/3 SOOW cable	1 $\emptyset$	6/10/30mA
LECI-402401	240V/40A	6' of 8/3 SOOW cable	1 $\emptyset$	6/10/30mA
LECI-402083	208V/40A	2' of 10/4 SOOW cable	3 $\emptyset$	6/10/30mA
LECI-402403	240V/40A	2' of 10/4 SOOW cable	3 $\emptyset$	6/10/30mA
LECI-602083	208V/60A	6' of 6/4 SOOW cable	3 $\emptyset$	6/10/30mA
LECI-602403	240V/60A	6' of 6/4 SOOW cable	3 $\emptyset$	6/10/30mA
LECI-404803	480V/40A	6' of 6/4 SOOW cable	3 $\emptyset$	6/10/30mA
LECI-604803	480V/60A	6' of 6/4 SOOW cable	3 $\emptyset$	6/10/30mA
LECI-606003	600V/60A	2' of 6/4 SOOW cable	3 $\emptyset$	6/10/30mA

### Lind Equipment Canada:

145 Renfrew Drive, Suite 150  
Markham, ON, CA, L3R 9R6  
Toll Free: 1.877.475.5463

### Lind Equipment USA:

300 International Drive, Suite 100  
Williamsville, NY, USA 14221  
Email: info@lindequipment.net



Lind Equipment



@LindEquipment



Lind Equipment



@LindEquipment

